

Report on Cost components of cross border exchanges of electricity

Prepared for the
Directorate-General for Energy and Transport / European Commission

Reference: Final report

Date: November 2002

Report on
Cost components of cross border exchanges of
electricity

Prepared for the
Directorate-General for Energy and Transport / European Commission

by

Ignacio Pérez-Arriaga
Luis Olmos Camacho
Francisco Javier Rubio Odériz

Instituto de Investigación Tecnológica
Universidad Pontificia Comillas
Madrid, Spain

Table of contents

Executive summary	13
The objective	13
The Florence Regulatory Forum	13
Cross-border tariffication and the inter-TSO payment mechanism	14
Evaluation of methods for determination of cost components in cross-border exchanges of electricity	16
The considered methods	16
Data requirements: current availability	18
Data requirements: future solutions	19
Results of the evaluation of the considered methods	19
Conclusions	23
1 Introduction and objectives of the study	29
1.1 The Florence process	29
1.2 Objectives of the study	30
1.3 Road map of this report	30
2 A comprehensive model of transmission regulation for the IEM within the Florence context	33
2.1 Cross-border tariffication	34
2.1.1 Cross-border tariffication principles that have been adopted in Florence	35
2.1.2 The provisional mechanism	40
2.1.3 The long-term mechanism	42
2.2 Network tariff harmonization	44

2.3	Congestion management.....	44
2.4	Transmission network investments	45
3	A critical review of methods for determination of cost components in cross-border exchanges of electricity	47
3.1	Compensations and charges due to utilization of networks by cross-border transactions and loop flows	47
3.1.1	Algorithm 1: Average participations (AP)	54
3.1.2	Algorithm 2: Simplified average participations (SAP)	61
3.1.3	Algorithm 3: Modified average participations (MAP).....	62
3.1.4	Algorithm 4: Marginal participations (MP)	64
3.1.5	Algorithm 5: With and without transit (WWT)	71
3.1.6	Algorithm 6: Average participations applied to transits (APT)	72
3.2	Compensations and charges due to losses	73
3.2.1	Algorithm 1: Average participations (AP)	73
3.2.2	Algorithm 2: Modified average participations (MAP).....	74
3.2.3	Algorithm 3: Marginal loss factors applied to border flows (MP)	74
3.2.4	Algorithm 4: With and without transits (WWT).....	76
3.2.5	Algorithm 5: Average participations applied to transits (APT)	76
3.2.6	Algorithm 6: Marginal loss factors applied to transits (MPT)	76
4	Data requirements.....	79
4.1	Data requirements.....	80
4.1.1	Sources of information.....	82
4.1.2	Data that have been used in this study.....	84
4.2	Methodology to determine the reference scenarios	85
4.2.1	Proposed method	85
4.2.2	Discussion of the results	87
5	Quantitative analysis of methods for cost allocation	95
5.1	The considered scenarios.....	95

5.2	Compensations and charges because of network utilization ...	99
5.2.1	Algorithm 1: Average participations (AP)	99
5.2.2	Algorithm 2: Simplified average participations (SAP)	108
5.2.3	Algorithm 3: Modified average participations (MAP).....	109
5.2.4	Algorithm 4: Marginal participations (MP)	111
5.2.5	Algorithm 5: With and without transits (WWT).....	115
5.2.6	Algorithm 6: Average participations applied to transits (APT)	116
5.3	Compensations and charges because of network losses.....	119
5.3.1	Algorithm 1 for loss allocation: Average participations (AP).....	120
5.3.2	Algorithm 2 for loss allocation: Modified average participations (MAP)....	121
5.3.3	Algorithm 3 for loss allocation: Marginal loss factors applied to border flows (MP)	122
5.3.4	Algorithm 4 for loss allocation: With and without transits (WWT).....	123
5.3.5	Algorithm 5 for loss allocation: Average participations applied to transits (APT)	124
5.3.6	Algorithm 6 for loss allocation: Marginal loss factors applied to transits (MPT).....	125
5.4	Information on the use of locational signals	126
5.4.1	Nodal transmission network tariffs.....	127
5.4.2	Loss factors in the IEM	130
5.5	Impact of new interconnections and increased commercial flows	131
6	Conclusions and recommendations	133
6.1	Conclusions regarding data requirements Current availability and future solutions	134
6.2	Conclusions regarding the evaluation of the considered algorithms.....	136
7	Bibliography	147
Annex 1.	The Florence process.....	149
Annex 2.	Principles of regulation of transmission network pricing	155

Annex 3. Notes on the allocation key in the provisional mechanism.....	159
Annex 4. Some conclusions from the benchmarking study on transmission tariffs in the IEM countries	165
Annex 5. On the choice of slack node in the MP method	169
Annex 6. The method of average participations: An example	171
Annex 7. An additional case example for the APT method	177

List of Figures

Figure 1: Allocation of the use of a transmission line	51
Figure 2: Proportionality principle in average participations	56
Figure 3: Political borders are ignored.....	57
Figure 4: Political borders are considered.	58
Figure 5: Two areas example.....	67
Figure 6: Definition of the flow pattern of the transit at the borders	69
Figure 7: Transit according to ETSO for two different network topologies.....	70
Figure 8: The influence of political borders on transits	71
Figure 9: Selection of Scenarios.....	86
Figure 10: Graph of type 1 for 11 clusters	88
Figure 11: Graph of type 1 for 12 clusters	89
Figure 12: Graph #2 for 11 clusters	90
Figure 13: Graph #2 for 12 clusters	91
Figure 14: Each one of the 12 clusters (I)	92
Figure 15: Each one of the 12 clusters (II).....	93
Figure 16: Aggregated data for the considered UCTE scenario	97
Figure 17: . Criteria to determine compensations and charges for the considered algorithms	98
Figure 18: Participation of generation and demand nodes in the lines	102
Figure 19: Participation of demand nodes in the lines	103
Figure 20: Participation of generation nodes in the lines.....	103
Figure 21: Participations > 10% for both generators and demands in the lines ...	104
Figure 22: Participations > 20% for both generators and demands in the lines ...	105
Figure 23: participations of the node 6006, which is located in Portugal, in the flows on the lines using the marginal participations method when only one node is considered as the slack.....	112
Figure 24: participations of the node 6006, which is located in Portugal, in the flows on the lines using the marginal participations method when a distributed slack bus is used.....	112
Figure 25: participations of the node 34724, which is located in Germany, in the flows on the lines using the marginal participations method when only one node is considered as the slack.....	113

Figure 26: : participations of the node 34724, which is located Germany, in the flows on the lines using the marginal participations method when a distributed slack bus is used.....	113
Figure 27: Transmission tariffs for consumers.....	128
Figure 28: Sorted consumer nodes by demand.....	128
Figure 29: Transmission tariffs for generators	129
Figure 30: Average transmission tariffs per country.	130
Figure 31: Scenario A of network flows	161
Figure 32: Scenario B of network flows	161
Figure 33: Comparison of actual transmission tariffs and per unit compensations (no net of charges) that are derived from inter-TSO payments	168
Figure 34: Five nodes example	172
Figure 35: Aggregated data for the considered NORDEL scenario.....	178

List of Tables

Table 1: Case example of participations of network use.....	52
Table 2: A plausible set of scenarios	93
Table 3: Aggregated data for the considered UCTE scenario	98
Table 4: Compensations and charges with the AP method, figures are expressed as a percentage of the total volume of the grid	100
Table 5: Compensations and charges with the average participations method when figures are expressed in number of lines	100
Table 6: Compensations and charges with the average participations method when figures are expressed in millions of euros	101
Table 7: Allocation of inter-TSO payments to the tariffs G and L (% of European Network).....	106
Table 8: . Compensations and charges with the SAP method	108
Table 9. Compensations and charges with the MAP method	110
Table 10: Compensations and charges with the WWT method	115
Table 11: Compensations and charges with the APT method	117
Table 12: Compensations and charges for losses with the AP method	120
Table 13: Compensations and charges for losses with the MAP method.....	121
Table 14: Compensations and charges for losses with the MP method	122
Table 15: Compensations and charges for losses with the WWT method.....	123
Table 16: Compensations and charges for losses with the APT method.....	124
Table 17: Compensations and charges for losses with the MPT method	125
Table 18: Average transmission tariffs per country ($\text{€} / \text{MW}$).....	130
Table 19: Compensations due to countries because of network use.....	137
Table 20: Charges to be paid by countries because of network use.....	137
Table 21: Inter-TSO payments because of network use.....	137
Table 22: Compensations for losses due to countries	138
Table 23: Charges to be paid by countries because of losses	138
Table 24: Inter-TSO payments because of losses	138
Table 25: Total economic compensations (M€) of network infrastructure costs ..	140
Table 26: Total economic charges (M€) because of network infrastructure costs	140
Table 27: Total volume of inter-TSO payments (M€) for network infrastructure costs	140

Table 28: Total economic compensations (M€) of losses.....	141
Table 29: Total economic charges (M€) because of losses.....	141
Table 30: Total volume of inter-TSO payments (M€) for losses.....	141
Table 31: Participations of the agents in the flows on the lines when the average participations method is applied to scenario A.....	161
Table 32: Participations of the agents in the flows on the lines expressed in per unit values when the average participations method is applied to scenario A.....	162
Table 33: Participations of the agents in the flows on the lines, expressed in per unit values, when the average participations method is applied to scenario A and an equal global weight 50/50 is used.....	162
Table 34: Participations of the agents in the flows on the lines when the average participations method is applied to scenario B.....	163
Table 35: Participations of the agents in the flows on the lines expressed in per unit values when the average participations method is applied to scenario B.....	163
Table 36: Participations of the nodes in the flows on the lines, expressed in per unit values, when the average participations method is applied to scenario B and an equal global weight 50/50 is used.....	164
Table 37: Allocation of flows in the lines to the injection nodes and to the withdrawal nodes of the network.....	173
Table 38: Allocation (in per unit) of line flows to nodes, separately for injection nodes and withdrawal nodes.....	174
Table 39: Final allocation (in per unit) of line flows to nodes, where and identical global weight is adopted for generators and loads.....	175
Table 40: Aggregated data for the considered NORDEL scenario.....	177
Table 41: Compensations and charges with the AP method when applied to NORDEL system. Figures are expressed as a percentage of the total volume of the NORDEL grid.....	178
Table 42: Compensations and charges with the APT method when applied to the NORDEL system. The figures are expressed as a percentage of the total volume of the NORDEL grid.....	178

Cost components of cross border exchanges of electricity

Executive summary

The objective

The objective of the present study is to provide the methodological basis for the implementation of the long-term mechanism of cross-border tariffication that, according to the conclusions of the Florence Forum, should be based on a scheme of inter-TSO payments. This study will explore possible methodologies for the allocation of cost components to cross-border exchanges of electricity, which is the basic information that is needed for cross-border tariffication. More specifically, the objective of the study is to examine different alternatives in order to propose a method that, within the guidelines established at the Florence Forum, can effectively compute the compensations, the charges and the net inter-TSO payments due to losses and network utilization that are incurred by cross-border transactions and loop flows.

The report does not directly deal with the questions of: a) how to value the cost of existing and future network assets; b) how to collect or to distribute payments for final network users, thereby resulting in detailed locational signals, although some elements to perform this task have been provided.

The report also presents additional material to place inter-TSO payments and cross-border tariffication into the wider context of transmission regulation in the Florence process.

The Florence Regulatory Forum

This study must be understood within the global effort that is taking place, within the European Union and at different fronts, with the purpose of achieving a workable and efficient Internal Electricity Market (IEM).

The Florence Regulatory Forum, —which has been organized by the European Commission—, has succeeded in bringing together the different stakeholders of the IEM to discuss and to build some consensus on the issue that is probably most difficult to solve when trying to achieve a working regional market: regulation of access, investment and pricing of the transmission network of the 17 countries that participate in the IEM.

Slowly, but gradually, the Florence process has built a preliminary vision or model of how transmission issues should be approached within the IEM. This model comprises four major elements, with each one of them providing an answer to a basic regulatory question within the context of the IEM:

- a) **Cross-border tariffication:** How much should be charged for the use of the network to the diverse market agents who can buy and sell anywhere within the IEM? Who pays for network losses?
- b) **Network tariff harmonization:** In the context of a regional competitive market, can the tariffs in the different countries be entirely left to subsidiarity or some level of harmonization should be required?
- c) **Congestion management:** How the priorities in network use are established when the transactions of the agents in the market are not compatible with the existence of physical network constraints?
- d) **Transmission network investment:** Who is responsible for upgrading the network when needed and who pays for it?

The pragmatic Florence approach appears to have now arrived at a juncture where key orientations have been adopted with regard to: a) the trend towards adopting the concept of the “single system paradigm” so that political borders will not finally matter in the design of the rules of functioning of the IEM; b) the need for a certain level of regulatory harmonization in the 17 IEM countries; c) the compliance with the laws of physics and the maintenance of sound criteria for security of supply.

A provisional mechanism of cross-border tariffication has been implemented on March 1st 2002 and it has finally succeeded in eliminating tariff “pancaking” in the IEM. However, the provisional mechanism contains serious regulatory imperfections. It was therefore agreed at the 8th Florence Forum in February 2002 that the provisional mechanism should not last more than the year 2002 and that it should be replaced by a long-term mechanism where these major imperfections would be eliminated. This study tries to provide methodological support for the design and implementation of the long-term mechanism.

Cross-border tariffication and the inter-TSO payment mechanism

The following principles for cross-border tariffication have been adopted at the Florence process¹:

- i) Separation of the treatment of short-term and long-term transmission related economic signals. Short-term signals will be mostly derived from network constraints, while long-term signals have the main purpose of recovering transmission costs and also of providing locational signals, mainly for the siting of new producers and demands.
- ii) Local —at country or TSO level— G (for generation) and L (for load) transmission tariffs provide access to the entire IEM without any supplementary border fees. This is a direct consequence of the “single system paradigm”.

¹ The description that follows corresponds to the free and unavoidably biased interpretation of the first author of this report, who has been actively involved in the Florence Forum since its inception. The reader can always consult the official texts at the website of the EU Commission.

- iii) Economic compensations among countries must be established because of the costs incurred by cross-border transactions and loop flows. Compensations should be paid to those countries that incur into extra costs because of cross-border trade, and charges should be levied on those countries that are responsible for these costs. Therefore, there will be no cross-border tariffs, but a compensatory scheme at country or TSO level.

The compensations are required because of two reasons: a) losses that take place in a country because of the existence of cross-border transactions and loop flows; b) utilization of the networks of other systems because of cross-border transactions and loop flows.

Therefore the compensatory mechanism consists of three basic steps: i) determination of the *compensation* that is due to each country because of the costs that are incurred by cross-border transactions and loop flows; ii) determination of the *charges* that each country has to pay in order to compensate others; iii) a method to reflect the results of the two previous steps in the national tariffs G and L.

- iv) Use of real flow network models, i.e. models that represent all the existing transmission lines with their actual power flows, in order to faithfully represent the reality of the functioning of the power system.
- v) Equal treatment of existing and future lines in the network cost allocation algorithms. This simplifies the network cost allocation procedures and it also allows the automatic treatment of new investments. A posteriori, regulators may decide to establish thresholds or limitations to the compensations corresponding to the existing network².
- vi) Use of standardized costs, —just for the purpose of computation of inter-TSO payments—; for the different transmission components.
- vii) Non transaction-based charges. Any charges that may be derived from the inter-TSO payments scheme, because of their intrinsic nature of long-term economic signals, must not depend on the specific commercial transactions among the market agents.

The net outcome of the compensatory mechanism, —the net inter-TSO payments—, will result in some changes to the local transmission tariffs in the different countries, thereby providing some locational signals at EU level. The limited functionality of the inter-TSO payment mechanism as a pan-European transmission tariffication system must be understood. The mechanism of inter-TSO payments, as agreed in Florence, cannot have much relevance as provider of detailed locational economic signals at individual nodal level, since it aggregates charges and compensations at TSO level. However, at TSO or country level, the

² The use of thresholds or limits to compensations on existing lines will find a justification when too crude or even arbitrary methods are employed in the computation of inter-TSO payments, so that unreasonable economic transfers are avoided. The better the representation of the reality of network utilization the lesser the need to introduce thresholds or discrimination between the treatment of existing and future lines.

locational signals will be correct. Strong short-term locational signals already exist in the pan-European schemes of congestion management that form part of the Florence global regulatory package.

Evaluation of methods for determination of cost components in cross-border exchanges of electricity

The considered methods

The study critically evaluates several alternative methods for determination of the elements of cost that must be employed in the long-term scheme of implementation of the mechanism of inter-TSO payments, as well as the data requirements for each one of these methods. Computer programs have been developed and data to apply them to relevant models of the Internal Electricity Market (IEM) have been collected, so that each method could be properly evaluated, both qualitatively and quantitatively.

Following the guidelines that have been established in Florence, the review of methods will be split into two blocks. On one hand the methods that deal with network **infrastructure** costs. On the other hand the methods for allocation of network **losses**. Obviously some of the methods in the two categories have many points in common.

Most of the considered options can be also grouped into two major categories, with each one of them offering several variants: a) methods that are based on the *allocation of the electrical use of each individual network facility*, with the method of average participations being the proposed choice, and b) methods that directly compute the compensations on the basis of the *impact of transit flows*, where the most representative case is the “with and without transit” algorithm.

Compensations and charges due to utilization of the networks' infrastructure

Based on the specific proposals that have been recently examined at the Florence Forum, this report has chosen for examination six different methods, which could be grouped into two major families:

Family 1: Based on the network utilization of individual agents and complete actual cross-border flows.

- Average participations (**AP**).

This is the classical average participations algorithm, which makes use of a simple heuristic rule to trace the source and the destination of the actual flow in each line of the system.

- Simplified average participations (**SAP**).

The AP algorithm is applied to a simplified model of the IEM network, where each country is represented by a single node.

- Modified average participations (**MAP**).

This modified version of the AP algorithm is meant to eliminate the external network use of those countries that are internally balanced in generation and demand, even though they may have transits. The external network use of a country j is then determined by collapsing its network into a single node with the balance of its total generation and demand. The network and flows outside country j are left intact. Then the AP algorithm is used to evaluate network participations.

- Marginal participations (**MP**).

This algorithm is based on the marginal changes in all the network flows that are caused by a marginal increment of the generation or the load at any given node. Only some test cases have been run in order to demonstrate the mechanics of the method and the effect of the choice of the reference node.

Family 2: Based on the impact of transit flows on each considered country.

- With & without transit method (**WWT**).

This is the direct approach of defining the transit for each considered country j , then creating a situation without the transit in country j and finally comparing the network utilization in country j in the two situations.

- Average participations applied to transits (**APT**).

Instead of creating the “without transit” situation, the AP algorithm is used to track the transit flows (defined as in the WWT algorithm) and to evaluate its impact on each considered country j .

Compensations and charges due to losses

The methods of allocation of losses that have been examined in this report are, for the most part, parallel methods to the ones that have been already presented for the allocation of the network infrastructure costs. However, some new algorithms have been introduced, which make use of marginal loss factors. Again, the methods could be grouped into two major families:

Family 1: Based on the network utilization of individual agents and complete actual cross-border flows.

- Average participations (**AP**).

It uses the results of the classical average participations algorithm.

- Modified average participations (**MAP**).

It uses the results of the modified average participations algorithm.

- Marginal loss factors applied to actual cross-border flows (**MP**).

Marginal loss factors are separately computed, -with an underlying philosophy similar to the MP method-, and then applied to the actual flows at the interconnections.

Family 2: Based on the impact of transit flows on each considered country.

- With & without transit method (**WWT**).

It uses the results of the “with and without transit” algorithm.

- Average participations applied to transits (**APT**).

It uses the results of the algorithm of average participations applied to transits.

- Marginal loss factors applied to transits (**MPT**).

Marginal loss factors are separately computed, -with an underlying philosophy similar to the MP method-, and then applied to the transit flows at the interconnections.

Data requirements: current availability

Despite the positive cooperation of ETSO and its member organizations, the process of data collection, validation and utilization has been slow and laborious. During the established duration of the project, the contractor has been able to run only one scenario with the data that have been formally provided by ETSO, and not for the entire IEM, but for just the UCTE system and, separately, also for the NORDEL system. Lack of consistency between the data of the few scenarios that have been made available and difficulties because the data needed skilful handling before they could be employed in any useful form, have prevented that results for more scenarios could be presented in this report. This does not invalidate the methodological conclusions of the study, but it prevents us from inferring valid quantitative estimates on inter-TSO payments from our results for a single scenario.

The quantitative analysis has focused on the scenario of the UCTE network corresponding to January 17th, 2001, at 10:30 am, with values that were estimated by the different system operators³. The table below summarizes some aggregated magnitudes of interest of the scenario, such as the internal generation and demand for each country or the number of nodes in the model for each country that are net generators or net demands, the exports, the imports as well as the net exports values for each country and the value of the transit, according to the definition that has been adopted by ETSO. The considered UCTE model as a whole has 5,681 lines and 3,383 nodes, with a total amount of production equal to 244.00 GW, a total load of 240.86 GW and losses of 3.14 GW. Some assumptions and simplifications have been made since some of the required data were not available. For instance, all lines have been assumed to be of equal length. Also, when a line crosses a border it has been assumed that half of it corresponds to each one of the two countries. Additionally, all the lines in the system have been considered to be single circuit lines. Of course this is not true but it allows us to make some good estimations of the results that would be obtained if the real network system had been used.

³ The partial results corresponding to the analysis of the NORDEL model are reported in Annex 7.

Country	Name	Demand	Generation	#D	#G	Exports	Imports	Net E-I	ETSO-T
E	Spain	29,090	28,289	197	103	554	1,851	-1,298	554
P	Portugal	6,364	6,891	35	20	755	361	395	361
F	France	64,804	74,126	677	184	8,487	193	8,293	193
I	Italy	31,480	26,508	217	112	0	5,321	-5,321	0
CH	Switzerland	5,720	5,877	53	37	2,686	2,604	82	2,604
D	Germany	50,150	49,649	367	93	3,887	5,042	-1,155	3,887
B	Belgium	7,170	6,405	31	12	1,053	1,752	-699	1,053
NL	Netherlands	10,651	7,134	34	14	325	3,923	-3,597	325
SLO	Slovenia	820	929	4	3	814	764	50	764
A	Austria	2,814	3,905	20	20	1,961	577	1,385	577
CZ	Czech Rep.	8,194	9,836	32	16	2,099	791	1,308	791
PL	Poland	15,449	16,032	106	29	843	235	608	235
BIH	Bosnia	316	671	6	7	146	146	0	146
HR	Croatia	995	1,122	7	7	733	684	50	684
H	Hungary	4,146	3,619	24	7	373	725	-352	373
SK	Slovak Rep.	2,616	2,759	24	10	569	567	3	567
UA	Ukraine	84	250	1	1	279	29	250	29

Data in MW

Aggregated data for the considered UCTE scenario (#D and #G stand for number of demand nodes and generation nodes, respectively); net E-I equals exports minus imports; ETSO-T is the value of the transit according to ETSO.

Data requirements: future solutions

Real flow network models require the utilization of a representative number of scenarios in order to be able to provide meaningful quantitative results. Undoubtedly, the best option is to use 8,760 hourly scenarios corresponding to the historical system behavior for the last available year. This is what NORDEL is presently using for network loss allocation between the Scandinavian countries.

However, collecting real flow data for every hour may be too demanding at the outset. This study has examined the possibility of using instead a reduced number of representative scenarios, conveniently weighed according to the number of hours that each one of them appears to represent. Despite the paucity of the data that have been made available for this analysis (two figures per hour for each country: internal demand and the net value of exports minus imports), the clustering techniques that have been employed in this study have shown that an acceptably low number of scenarios (about twelve) suffices to describe all the patterns of export and import flows in the entire year. However, it remains to be proved that network utilization factors correlate well with patterns of import and export flows.

Results of the evaluation of the considered methods

It must be taken into account that the numbers in this report are based on the analysis of a single scenario. Therefore, they can be considered only for the purpose of comparison between network cost allocation algorithms, and not to infer the final results of compensations, charges and inter-TSO payments among countries.

Tables A, B and C summarize the results that have been obtained with five out of the six considered methods for the allocation of network infrastructure costs: average participations (AP), simplified average participations (SAP), modified average participations (MAP), the “with and without transit” method (WWT) and average participations applied to transits (APT). Complete numerical results for the method of marginal participations (MP) have not been obtained, since the method was preliminarily discarded from the point of view of calculating inter-TSO compensation payments, because of other considerations: too much dependence of arbitrary modeling decisions, —such as the choice of reference node—, and inability to reflect the actual flow patterns and the limited network capacities.

Table A shows the compensation due to each one of the countries because of the use that others have made of its network. Table B shows the charge that each one of the countries has to pay because of the use it has made of other networks. Finally Table C shows the net outcome of compensations and charges for each country, i.e. the Inter-TSO payments. Thus, when an Inter-TSO payment for a country is positive it means the amount of money the corresponding country must receive and when the Inter-TSO payment is negative it means the amount of money the country must eventually pay as a result of the application of the Inter-TSO payment mechanism. All figures in these tables correspond to percentages of the total number of equivalent 400 kV lines in the considered UCTE network model, which happens to be 3,655 lines⁴. For instance, 0.35 in Table A means that, according to the method of average participations (AP), Spain must receive a compensation for the utilization of 12.79 lines. This number of lines corresponds to 0.35 % of the total number of equivalent lines of 400 kV in the UCTE network, that is $0.35 \times 3,655 / 100 = 12.79$ lines.

A first impression from observation of the tables is that significant numerical differences exist between the methods, although some persistent patterns of behavior can be easily identified⁵. For instance, heavily importing or exporting countries, such as Italy or France, respectively, have large compensations (except in the WWT and APT methods) but even larger charges, resulting in significant negative inter-TSO payments, i.e. they have to pay. On the other hand, well balanced and heavily transited countries such as Switzerland have large compensations and small charges (this effect is emphasized in the MAP, WWT and APT methods), therefore resulting in large positive inter-TSO payments, i.e. they are paid by others⁶.

⁴ In order to address the problem of the lack of data on line lengths and standard network costs, the following decisions have been adopted: a) all lines will be considered of equal length; b) based on available cost information, it will be assumed that 1 km of a line of 220 kV is equivalent to 0.66 km of a line of 400 kV, and 1 km of a line of 132 kV is equivalent to 0.44 km of a line of 400 kV; c) for the time being, some transformers have been considered as lines of 400 kV, while others as lines of 220 kV or as lines of 132 kV. In this way all the results of charges and compensations can be expressed in terms of number of lines of 400 kV.

⁵ It is recalled here that the results for the AP and WWT methods can be only compared for the net inter-TSO payments, but not for compensations or losses separately, as explained in section 3.1.5.

⁶ Note that this result cannot be extended to all possible cases of well balanced and “heavily transited” countries, if ETSO’s definition of transit is used since, by definition, the results of real flow

The pattern is less clear for countries that are simultaneously being transited while they also are net exporters or importers. This is for instance the case of Germany or Portugal, where the outcome of the WWT method for the net inter-TSO payments is opposite to the results of all the other algorithms, and also the case of The Netherlands, where AP is the only method in opposition to all the others.

It is also interesting to observe how the MAP and the APT methods tend to reduce the charges for well balanced countries, —i.e. countries with approximately the same volume of internal demand and generation—, and the similarity of their results for the net values of inter-TSO payments.

	E	P	F	I	CH	D	B	NL	SLO	A	CZ	PL	BIH	HR	H	SK	UA
AP	0.35	0.11	0.87	0.73	1.11	1.34	0.22	0.39	0.11	0.44	0.21	0.18	0.08	0.16	0.13	0.22	0.03
SAP	0.24	0.06	1.70	1.01	1.00	1.70	0.31	0.33	0.11	0.40	0.20	0.20	0.00	0.08	0.13	0.20	0.02
MAP	0.21	0.05	0.54	0.48	0.90	0.99	0.21	0.01	0.05	0.14	0.07	0.01	0.00	0.10	0.05	0.16	0.01
WWT	-0.09	0.20	0.00	0.00	1.25	-0.30	0.08	0.09	0.10	0.32	0.07	0.02	0.16	0.25	0.12	0.05	0.00
APT	0.17	0.07	0.03	0.00	1.13	1.16	0.16	0.05	0.12	0.21	0.13	0.10	0.08	0.16	0.10	0.23	0.01

Table A. Compensations due to countries because of network utilization

	E	P	F	I	CH	D	B	NL	SLO	A	CZ	PL	BIH	HR	H	SK	UA
AP	0.30	0.19	1.48	1.02	0.60	0.94	0.24	0.31	0.10	0.35	0.43	0.16	0.02	0.20	0.13	0.15	0.06
SAP	0.24	0.07	1.73	1.25	0.61	1.01	0.32	0.81	0.11	0.43	0.57	0.13	0.00	0.07	0.18	0.11	0.04
MAP	0.18	0.07	1.49	1.02	0.02	0.10	0.07	0.30	0.01	0.26	0.26	0.08	0.00	0.01	0.05	0.00	0.06
WWT	0.09	0.03	0.81	0.26	0.06	0.27	0.07	0.18	0.04	0.14	0.16	0.07	0.01	0.03	0.03	0.03	0.02
APT	0.09	0.10	0.84	0.64	0.17	0.44	0.03	0.32	0.05	0.30	0.36	0.17	0.02	0.16	0.10	0.07	0.05

Table B. Charges to be paid by countries because of network utilization

	E	P	F	I	CH	D	B	NL	SLO	A	CZ	PL	BIH	HR	H	SK	UA
AP	0.05	-0.08	-0.61	-0.29	0.51	0.40	-0.02	0.07	0.01	0.09	-0.22	0.02	0.06	-0.04	0.01	0.07	-0.03
SAP	-0.01	-0.01	-0.04	-0.24	0.39	0.69	-0.01	-0.48	0.00	-0.03	-0.37	0.07	0.00	0.01	-0.05	0.09	-0.02
MAP	0.03	-0.02	-0.95	-0.54	0.89	0.89	0.14	-0.29	0.05	-0.11	-0.19	-0.08	0.00	0.09	-0.01	0.16	-0.05
WWT	-0.19	0.17	-0.81	-0.26	1.19	-0.57	0.01	-0.10	0.06	0.19	-0.08	-0.05	0.15	0.22	0.09	0.02	-0.02
APT	0.08	-0.02	-0.81	-0.64	0.96	0.72	0.13	-0.27	0.07	-0.09	-0.23	-0.07	0.06	0.00	-0.01	0.16	-0.04

Table C. Inter-TSO payments because of network utilization

Tables D, E and F summarize the results that have been obtained with the six considered methods for the allocation of network losses: average participations (AP), modified average participations (MAP), marginal loss factors applied to complete border flows (MP), the “with and without transit” method (WWT),

network models depend on the internal pattern of flows in the country, while ETSO’s definition of transit does not. One could easily imagine counterexamples.

marginal loss factors applied to transit flows (MPT) and average participations applied to transits (APT). All figures in the tables correspond to MW of losses.

In this case the dispersion of the results is even larger than for the allocation of the costs of network infrastructure. Systematic patterns of behavior have not been identified. Net inter-TSO payments with the AP method are generally smaller than with any other method, while the two methods that are based on marginal loss factors typically result in the largest inter-TSO payments. An explanation for this is the quadratic nature of the network losses and therefore the fact that marginal factors result in compensations that roughly double the actual amount of incurred losses.

	E	P	F	I	CH	D	B	NL	SLO	A	CZ	PL	BIH	HR	H	SK	UA
AP	15.9	8.0	51.4	35.5	24.9	43.7	6.2	17.5	3.3	11.5	6.8	4.4	4.3	4.3	3.0	2.3	0.2
MAP	9.4	2.8	33.4	23.0	22.2	35.3	6.0	0.5	1.7	3.9	2.4	0.0	0.1	1.9	0.9	1.8	0.1
MP	26.7	19.9	28.9	10.0	91.8	97.0	21.6	9.1	17.0	30.2	25.5	6.0	14.5	13.0	14.4	10.4	0.9
WWT	-20.4	5.0	-16.0	0.0	15.1	-38.5	-1.1	2.3	-2.8	7.9	-4.1	-3.3	8.0	-69.6	1.0	-8.6	0.0
MPT	-17.8	2.9	-4.1	0.0	31.6	23.3	-1.5	0.4	-2.7	5.8	-0.8	-2.4	7.9	-9.7	0.3	-3.1	0.0
APT	6.9	6.0	1.7	0.0	25.1	37.0	5.0	2.2	3.2	5.1	4.0	2.5	4.3	4.3	2.5	2.4	0.1

Table D. Compensations for losses due to the different countries

	E	P	F	I	CH	D	B	NL	SLO	A	CZ	PL	BIH	HR	H	SK	UA
AP	20.1	9.6	50.8	40.7	19.9	30.6	13.3	13.2	1.7	11.7	13.9	3.7	1.0	7.6	2.0	2.9	0.5
MAP	11.0	4.0	49.5	40.4	0.5	3.2	3.7	12.9	0.1	8.5	8.1	2.2	0.0	0.3	0.5	0.0	0.5
MP	23.9	21.0	77.6	88.0	17.1	24.3	17.8	46.1	13.9	0.5	42.4	26.0	0.4	17.4	4.3	12.3	4.1
WWT	-4.4	-2.0	-38.6	-14.8	-8.4	-9.6	-4.3	-11.3	-2.3	-9.9	-9.2	-3.9	-0.4	-1.0	-2.0	-1.5	-1.4
MPT	-0.4	-13.0	14.4	25.7	1.4	-2.7	1.7	8.3	0.9	-5.9	9.2	-1.0	-10.0	3.6	-3.5	2.6	-1.0
APT	6.7	4.4	22.2	18.5	2.2	8.7	2.0	13.3	1.0	7.8	10.7	3.8	1.0	6.8	1.7	1.2	0.3

Table E. Charges to be paid by the different countries because of losses

	E	P	F	I	CH	D	B	NL	SLO	A	CZ	PL	BIH	HR	H	SK	UA
AP	-4.2	-1.6	0.6	-5.2	5.0	13.1	-7.1	4.3	1.6	-0.2	-7.1	0.7	3.3	-3.3	1.0	-0.6	-0.3
MAP	-1.6	-1.2	-16.1	-17.4	21.7	32.1	2.3	-12.4	1.6	-4.6	-5.7	-2.2	0.1	1.6	0.4	1.8	-0.4
MP	2.8	-1.0	-48.7	-78.0	74.7	72.7	3.8	-37.0	3.1	29.7	-17.0	-20.0	14.1	-4.4	10.1	-1.9	-3.2
WWT	-16.0	7.0	22.6	14.8	23.6	-28.9	3.2	13.6	-0.5	17.8	5.0	0.6	8.5	-68.5	3.0	-7.1	1.4
MPT	-17.4	15.9	-18.5	-25.7	30.2	26.0	-3.1	-7.9	-3.6	11.7	-10.0	-1.4	17.9	-13.3	3.8	-5.7	1.0
APT	0.2	1.6	-20.5	-18.5	22.9	28.3	3.0	-11.1	2.2	-2.7	-6.7	-1.3	3.3	-2.5	0.8	1.2	-0.2

Table F. Inter-TSO payments because of losses

A first estimate of the economic implications of each method

In order to have a rough idea of the order of magnitude of the volume of economic compensations, charges and inter-TSO payments with the different methods, the numerical results in the previous section have been applied to estimated average

lengths of lines (the same length for all lines) and to standard regulated costs of lines that have been derived from the current Spanish regulation (see sections 5.2.1 and 6.2 for more details). The word of caution has to be repeated here: not only are we using the figures from a single scenario, but we are also employing an estimation of the values of costs and lengths of the lines. However, the results will be useful to establish some additional comparisons among the different methods and to estimate some order of magnitude of the expected outcome of application of the different algorithms. One more method has been added to the evaluation: the provisional method (PM) of ETSO, but now applied only to the single available scenario, so that it can be compared to the real flow network methods being examined in this report.

The evaluation is limited to the 9 countries of the IEM within the UCTE, since the provisional method has only been applied to them. As expected, the results show that the average participations method (AP) will have a larger volume of compensations than others (except for the simplified average participations method, SAP), since AP gives compensations to countries without transits, while WWT, for instance, does not. However, what matters is not the intermediate values of compensations and charges, but the values of net inter-TSO payments, i.e. the volume of money that, in the end, each country will have to receive or to pay, because of the inter-TSO payment mechanism. When the absolute values of inter-TSO payments for the 9 countries are aggregated, the results show that most methods have a similar figure of aggregated inter-TSO payments, with average participations (AP) being among the methods with the lowest volume of net payments and the provisional method (PM) yielding the highest one.

The results also show the reduced quantitative importance of the compensations, the charges and, particularly, the inter-TSO payments associated to losses, —for most of the considered methods—, when compared to the corresponding values for the network infrastructure costs. The AP method results in the lowest value, among all methods, for the inter-TSO payments that are derived from network losses.

Conclusions

Global conclusion

The major conclusion of the study is that algorithms that are based on real flow network models can be used for the computation of inter-TSO payments and they are far superior to the present provisional mechanism. Data requirements to feed these models are demanding but feasible. A few alternative options exist regarding the specific algorithm to be used, with each one of them reflecting different underlying regulatory criteria and resulting in outcomes with significant numerical differences.

Detailed conclusions

The detailed conclusions of the report can be grouped into two major categories. The first one concerns the data requirements. The second one refers to the qualitative and quantitative evaluation of each method.

Conclusions regarding data requirements.

Data collection and validation

The practical problems that the contractor has experienced could be reduced to almost zero with adequate standardized procedures of data collection and validation. It has to be realized that network cost allocation, —or any other major tasks with mostly economic implications—, have not been part of the responsibilities of ETSO organizations such as UCTE, who are mostly devoted to operational and security issues.

In order to be able to start with a long-term mechanism for inter-TSO payments that is based on real flow network models, ETSO must make available the human and computational resources, as well as implement procedures for systematic data collection and handling that are needed for this task.

The number of scenarios

It is recommended to use 8,760 hourly historical scenarios of the last available complete year. This would eliminate any discussion on the procedure of selection of any reduced set of scenarios. However, if it is deemed that such a reduced number of representative scenarios should be employed instead, this study indicates that it seems plausible that these representative scenarios exist and that they could be determined via the clustering techniques that have been presented in this report.

A more conclusive evaluation of the precision of the approach would need a much more abundant provision of data than the one that has been made available.

A pragmatic recommendation, regarding the implementation of the long-term mechanism by January 2003, is to determine a provisional estimate of the values of the inter-TSO payments for the year 2003 on the basis of any available scenarios. Systematic data collection should start as soon as possible and not later than January 1st 2003. Assuming January 1st 2003 is the starting date, and based on the data collected for 2003, it would be possible to decide that a revision of the provisional estimate would be done at the end of 2003 and the provisional inter-TSO payments would be adjusted accordingly.

Conclusions of the comparative evaluation of the considered methods

In the end, the final comparison has to be made between two basic approaches: the average participations (AP) method, with the modified average participation (MAP) method as an interesting variant, and the “with and without transit “ (WWT) method, with the method of average participations applied to transits (APT) also as a variant. The study has identified the pros and cons of each option and it is left to regulators to make a final choice on the basis of this evaluation.

The simplified average participations (SAP) method should be discarded from the outset, since it is only a simplified version of the AP method and the observed lack of accuracy in the numerical results indicates that the method appears to be unacceptable. The method of marginal participations (MP) should be also abandoned from the point of view of calculating inter-TSO compensation payments, because of the dependence of its results on the choice of a reference node and also because of its inability to reflect the actual patterns of flow and the capacity of the interconnections. The two methods for dealing with losses by means of marginal loss factors will also be ignored, since they also depend on the choice of the reference node and, specially, since they cannot be applied to the allocation of infrastructure costs. However, methods that are based on marginal participations may be considered as valid approaches for providing locational signals, as a separate exercise to the determination of inter-TSO payments. Further investigation of this possibility is not, however, considered in the current study.

Although none of the remaining methods can be proved to provide the indisputable solution to the problem of allocation of network costs, the comprehensive examination of the performance of the methods allows one to clearly identify winners and losers. Let us concentrate first on the “with and without transits” approach WWT and the method of average participations AP. It follows a summary of their strong and weak points:

- The AP method is fully consistent with the “single system paradigm”, i.e. it is based on nodal transmission tariffs that are computed, -just for the purpose of the inter-TSO mechanism-, by the allocation of the electrical use of each transmission facility, with independence of the political borders or configurations of TSOs. All the actual physical flows are considered in the AP method. On the other hand the WWT method is specifically based on the definition of transit for each country or TSO, which is a concept that directly depends on the flows at the political borders and only makes use of a fraction of these flows. WWT therefore departs from the “single system paradigm” and implies a special treatment for a certain type of flows: the transits, with their ad hoc and controversial definition. The procedures of the WWT method, as well as its results, are very dependent on political borders between countries, or boundaries between TSOs.
- Both methods start off from some heuristic and reasonable assumptions. The WWT method makes use of the intuitive but ambiguous concept of “transit” of a country and adopts a definition for it. The AP method assumes that it is possible to trace the origin and the end of the flows and applies a simple proportionality branching rule for this purpose. The essential advantage of this approach is that, once the flow tracing rule has been accepted, everything else directly follows: nodal transmission tariffs, compensations, charges, inter-TSO payments and their assignment to the local G and L charges, allocation of the costs of new investments, and so on. On the other hand, the WWT method requires additional assumptions or ad hoc rules in order to determine charges and inter-TSO payments, or to assign the costs of a new network investment. As it is now, the allocation of charges in WWT ignores the topology of the IEM system and spreads the charges of any country over most other countries. It is

particularly serious that WWT only computes compensations, and other method has to be devised in order to determine the charges and inter-TSO payments. Undoubtedly, some parties or institutions may prefer the ambiguity and space for negotiation that the WWT method provides to the transparency and determinism of the AP approach, but this should not be seriously considered as a methodological advantage.

- Both methods yield numerical results that, in general, make economic and engineering sense. The results for both methods are different, although there are important similarities in broad terms, i.e., which countries should receive the largest compensations or which ones should pay the most. These discrepancies were expected, since both methods have essential differences: AP is based on the complete physical flows, while WWT looks for the impact of just the transit flows at the borders between countries and it ignores the physical flows in the allocation of charges (in its present implementation). In quantitative terms, both methods can only be compared on the basis of the final net inter-TSO payments that result from the application of compensations and losses to each country.
- Despite the methodological differences, both methods have provided inter-TSO payments of almost the same global economic volume, —and both lower than with the provisional method—, when applied to the single scenario that has been examined in detail.
- Data requirements are similar for both methods, since they make use of real network flows for a representative number of scenarios. There are, however, some differences.
- Cross-border tariffication is just one among several pieces of the puzzle of transmission regulation in the IEM, with others being congestion management, transmission tariffication and tariff harmonization —with particular attention to the provision of locational signals—, and treatment of new investments. The AP method can be used, if desired, as an aid in performing some of these tasks, while WWT can exclusively be used for the computation of compensations to countries because of transits. This feature will become very relevant shortly, in the discussion of the allocation of the costs of new network reinforcements. This issue is automatically taken care of in the AP method by just including the new investment in the real network flow model.
- Because it is based on transits, the WWT method tends to *emphasize* the support to transited countries at the expense of mostly exporting or importing countries, while the AP method is more neutral in this respect. This may be at odds with some of the conclusions of the Florence Regulatory Forum, and in particular with the request by the regulators that also the commercial and security related benefits of transits and interconnections should be somehow accounted for in the final evaluation. Another issue is related to the exclusive utilization of transits in WWT versus employing the complete cross-border flows in AP.

In conclusion, it seems fair to say that in most of the considered categories for comparison the AP method appears to be superior to WWT. The variants to both AP and WWT methods must be also commented. MAP responds to a potential

criticism to the AP method, when examined with a “non single system paradigm” mentality: small and heavily transited countries that are well balanced in generation and demand may happen to use much other countries’ networks and end up with small or even negative net inter-TSO payments. This may very well happen, -although it has not been the case in the scenario that has been examined in this study-, and the AP method provides the correct answer under a “single system paradigm” perspective. The numerical results that have been obtained confirm that the MAP method achieves the purpose for which it has been conceived. It is obviously a regulatory matter whether to accept or not temporarily this potential criticism to the AP method, while the “single system paradigm” mentality becomes fully accepted. Note the points in common with the discussion above about the potential discrepancies of the WWT method with some of the recommendations of the Florence Forum.

The other variant, —now with respect to the WWT method—, is the average participations applied to transits (APT) method. APT tries to eliminate some practical implementation difficulties of the WWT algorithm, while preserving the same philosophy of relating all external network use to the concept of transit. APT does not require the specification or utilization of a “without transit” operating condition and APT is able to identify the responsibilities for the transits, therefore providing a solution to the problem of allocation of the charges, which the WWT method is unable to address. The advantages of APT with respect to WWT deserve that the APT method should be seriously considered as a preferred candidate to the WWT method. However, APT is not free from criticism: It relies on the ambiguous concept of transit and it results in no compensations, but normal charges, for purely importing or exporting countries, which therefore tend to be unfavorably treated. Although APT is a new algorithm that has been developed during the course of this project, no impediment has been identified so that it could not be regarded as a solid alternative to WWT. An additional case example (the NORDEL system) has been run to gain more experience with the application of the APT method (see Annex 7) and the results confirm the above conclusions.

When all the above considerations are jointly considered, this study must conclude that the method of average participations (AP) is clearly the preferred approach, among all the methods that were initially selected as potential candidates to perform the task of allocation of network charges, in the computation of inter-TSO payments.

Despite some shortcomings, —in particular its inability to provide a solution to the computation of charges, its bias towards transited countries and potential inconsistencies with the guidelines of the Florence Forum, the “with and without transit” (WWT) method would represent a considerable improvement over the provisional approach, depending of course on the adopted procedure to compute the charges. Therefore, in case the family of “with and without transits” approaches is adopted for the task of computation of inter-TSO payments, the APT method should be given due consideration since it successfully addresses some of the implementation problems with the WWT approach.

1 Introduction and objectives of the study

This study on “Cost components of cross-border exchanges of electricity” must be understood within the context of the global effort that is taking place, within the EU and at different fronts, with the purpose of achieving a workable and efficient Internal Electricity Market (IEM).

1.1 The Florence process

The Florence Regulatory Forum, —which has been organized by the European Commission—, has succeeded in bringing together the different stakeholders, — Member States, regulators, system operators, consumer associations, power exchanges, brokers, etc.—, to discuss and to build some consensus on the issue that is probably most difficult to solve when trying to achieve a working regional market: regulation of access, investment and pricing of the transmission network of the concerned countries, in this case the 17 countries that presently participate in the IEM of the EU. As a result of the Florence process⁷, and despite the slow rate of progress during its more than three years of existence, a broad preliminary consensus has been achieved on a set of fundamental issues concerning the scheme of cross-border tarification (CBT) to be adopted for the IEM and a provisional mechanism of cross-border tarification has been implemented on March 1st 2002.

The provisional mechanism finally has succeeded in ending the current practice of network tarification in Europe that inevitable resulted in the undesirable effect of “pancaking” or accumulation of network tariffs, which was an important barrier to international trade in electricity. However, the provisional mechanism, because of the need to achieve a consensus that could finish with pancaking as soon as possible, contains serious regulatory imperfections. It was therefore agreed at the 8th Florence Forum in February 2002 that the provisional mechanism should not last more than the year 2002 and that it should be replaced by a long term mechanism where these major imperfections would be eliminated.

Cross-border tarification is just one among several aspects of transmission regulation that compose the global approach that is being gradually adopted at the Florence Forum. Congestion management, network tariff harmonization and mechanisms for network reinforcement are other equally important issues that cannot be addressed in isolation, as the success of the global approach depends on the coordinated development of all of them.

⁷ See Annex 1 for a detailed account of the progress that has been made along the 8 sessions (up to February 2002) of this Forum.

1.2 Objectives of the study

The objective of the present study is to provide the methodological basis for the implementation of the long term mechanism of cross-border tariffication that, according to the conclusions of the Florence Forum, should be based on a scheme of inter-TSO⁸ payments. More specifically, the objective of the study is to examine different alternatives in order to propose a method that, within the guidelines established at the Florence Forum, can effectively compute the compensations and charges due to losses and network utilization that are incurred by cross-border transactions and loop flows.

This study also tries to contribute to the development of the global approach to transmission regulation for the IEM that is being developed at the Florence Forum. Consequently, the report makes an effort to clarify which is the role of cross-border tariffication, —which is but one piece among the several ones that compose the comprehensive model—, in the global picture.

1.3 Road map of this report

This report contains the qualitative and quantitative comparative analysis of alternative mechanisms for the network cost allocation in the IEM, as well as recommendations on the preferred method for the implementation of the long-term mechanism for inter-TSO payments. The report also provides additional material to place inter-TSO payments and cross-border tariffication into the wider context of the Florence process. The contents of the report are organized to meet these two major objectives.

After this introduction, Chapter 2 presents the vision or model that has been built along the Florence process on how transmission issues should be approached in the Internal Electricity Market. This chapter provides the context within which the methodologies that will be presented in this study will have to be evaluated. Particular attention is devoted to the analysis of the major shortcomings of the provisional mechanism and the need to replace it by a long-term one. Chapter 3 describes the alternative methods for determination of compensations and charges that have been identified as most promising for the purposes of this study. Two groups of methods have been considered, according to whether they refer to compensations and charges associated to losses or to network utilization. The critical issue of data requirements and availability, in particular the definition of a reduced set of network flow scenarios on which to base the computation of the amounts of money to be actually exchanged every year among the TSOs, is

⁸ TSO stands for “Transmission System Operator”, which is the term that has been adopted to designate the entity that is in charge of operating the electric power system, with a special responsibility on preserving the security of the system while allowing the commercial transactions that the purchasing and selling agents are entitled to engage in. In most countries the TSO is also owner of transmission assets, which is the reason for the name TSO, although it is not the case in all systems. Most European countries have a single TSO per country, but some countries have several TSOs (Germany has 6, Switzerland has 5, Denmark has 2 and Austria has 2), which apply different transmission network tariffs within their territories. In this report the terms “country”, “TSO” and “Member State” will be indistinctly used for the only purposes of cross-border tariffication.

discussed in Chapter 4. Chapter 5 presents the quantitative results of the application of the different algorithms that were selected in Chapter 3. Finally, Chapter 6 contains the conclusions of the study and the recommendations for implementation of the long term mechanism.

Several annexes provide additional information on specific topics. Annex 1 summarizes the major conclusions that have been reached in the Florence Regulatory Forum on the topic of cross-border tariffication. Annex 2 provides theoretical background on regulatory principles for transmission pricing. The most salient shortcomings of the provisional mechanism of computation of inter-TSO payments are exposed in Annex 3. Annex 4 summarizes the conclusions of a recent study on benchmarking of transmission tariffs in the IEM countries; these conclusions allow one to better understand the role and the relevance of the mechanism of inter-TSO payments within the global picture of network tariffication in the IEM. Annex 5 is of a more technical nature and presents some mathematical properties of nodal prices that allow one to understand the implications of the choice of the slack node in the algorithms for network cost allocation. Annex 6 describes the method of average participations (AP) with some technical detail. Finally, Annex 7 presents the results of the comparison between some of the considered approaches when applied to an additional case example: the NORDEL electric system.

2 A comprehensive model of transmission regulation for the IEM within the Florence context

Transmission network regulation is still an open area of research and none of the many different approaches that have been implemented around the world, —even at the single country level—, may claim to be free of some significant amount of criticism. Transmission regulation has to meet a number of basic requirements so that it is compatible with sound engineering, economic and legal principles. Annex 2 provides a cursory account of these requirements, —which are not free from conflict with one another—, and presents the guidelines that a plausible regulatory approach should follow. The difficulty of the task grows in several dimensions when transmission regulation is addressed at a regional or multinational context. Why? Many countries are involved, with different regulations and very different characteristics: some of them are mostly importers, other mostly exporters, some are mostly transited countries, large and small, well connected or almost isolated, and each one with its own claims to be fairly treated. In order to be successful, an approach has to be faithful to the basic regulatory requirements, it has to be based on sound economic and engineering principles, and it also must be robust enough to withstand the scrutiny of any parties that feel to be negatively affected, so that a broad consensus may be reached or, at least, the adopted regulatory measures do not find too harsh a resistance to be accepted.

Slowly, but gradually, the Florence process has built a certain vision or model of how transmission issues should be approached within the IEM. This vision is still somewhat blurred in some respects, but by now it has achieved a recognizable shape. The model comprises four major elements, with each one of them providing an answer to a basic regulatory question within the context of the IEM, where producers and a large number of consumers of electricity have the right to buy and sell under freely established terms:

- a) **Cross-border tariffication:** How much should be charged for the use of the network to the diverse market agents who can buy and sell anywhere within the IEM? Who pays for network losses?
- b) **Network tariff harmonization:** In the context of a regional competitive market, can the tariffs in the different countries be entirely left to subsidiarity or some level of harmonization should be required?
- c) **Congestion management:** How the priorities in network use are established when the transactions of the agents in the market are not compatible with the existence of physical network constraints?
- d) **Transmission network investment:** Who is responsible for upgrading the network when needed and who pays for it?

The pragmatic Florence approach appears to have now arrived at a juncture where key orientations have been adopted so that the concept of the “single system

paradigm”, —i.e. the functioning of an electricity market where political borders do not matter—, should guide the design of the rules for the IEM. This is being achieved despite two major difficulties in this process. In the first place, the fact that the IEM comprises 17 countries with different regulatory approaches and pace of liberalization, where agents have access to an increasing number of Power Exchanges or they can engage into private bilateral transactions, and where *the extent of harmonization in market rules and network regulation cannot reasonably surpass a certain level*, at least for the time being. In the second place, the indisputable *need to comply with the laws of physics* and with a set of criteria that are of essence to maintain the security of supply in the operation of the power system of the IEM.

This chapter describes the model of transmission regulation that is emerging from the Florence process. It will consecutively address the four major issues that have just been identified: cross-border tariffication, network tariff harmonization, congestion management and transmission network investment. More attention will be devoted to the first issue, because of two reasons: Firstly, cross-border tariffication has been the major concern of the Florence process so far, so more progress has been made here than in other topics. Secondly, this study is about identifying and computing the cost components that are involved in cross-border exchanges of electricity, which is the basic information that is needed for cross-border tariffication.

One word of caution. The description that follows corresponds to the free and unavoidably biased interpretation of the first author of this report, who has been heavily involved in the Florence process since its inception. In some places this description includes the rationale that the first author considers is behind some of the conclusions. In other places the implications of some of the Florence conclusions might have been developed much further than strictly justified. The reader can always consult the official texts at the website of the EU Commission.

2.1 Cross-border tariffication

Significant advances have been made at the Florence Forum on cross-border tariffication, most of them in agreement with the sound transmission pricing principles that are presented in Annex 2. The principles that have been agreed in Florence shall form the base of a long-term mechanism of cross-border tariffication, whose implementation has been scheduled by January 2003. In the meantime, while the details of the long-term mechanism are being decided (this project is part of this effort), a provisional mechanism has been put in place by March 1st of 2002. This mechanism has many deficiencies, but it has replaced the previous mechanism that inevitably led to pancaking of tariffs for cross-border transactions, therefore discouraging international commerce.

The cross-border tariffication principles that have been adopted in Florence will be described first, then the provisional mechanism will be presented and its shortcomings will be examined. Finally, the guidelines to establish the long-term mechanism will be provided.

2.1.1 Cross-border tariffication principles that have been adopted in Florence

A. Separation of the treatment of short-term and long-term transmission related economic signals

The operation of the power system requires that network losses and network constraints⁹ should be somehow incorporated into the energy market processes. This is necessary because of efficiency reasons and also to preserve system security. *This is a short-term issue*, in the realm of system operation, and it must be addressed with short-term economic signals. But this is only part of the problem, since one also has to design transmission tariffs that recover the regulated transmission costs. And in actual networks this is not possible, as theory shows and practice has demonstrated systematically, by the simple application of short-term economic signals. Even with nodal energy prices¹⁰, which are able to internalize the effect of network losses and constraints entirely, the cost recovery rarely exceeds 20% of the total network costs. Then *we are facing a long-term issue*, i.e. the design of long-term tariffs that are set typically for one entire year, where the main objective is to recover the regulated network costs, but also to try at the same time to charge these costs to the network users in direct relationship with their responsibility in that these costs had been incurred.

Short-term signals (efficiency and security of system operation). Conceptually, it is recognized that a system of EU-wide nodal-or even zonal-, energy prices would be the ideal approach to send short-term efficient network signals to all the market agents. However, it is also acknowledged that in the short term this is not an acceptable scheme, given the large diversity of regulatory practices in the IEM countries and the time and effort that takes to modify them. This is why it has been agreed to make use of ad hoc mechanisms to send these short-term network signals throughout the IEM as three separate pieces: a) the price of energy in the several markets and some mechanisms that reflect the impact of b) losses and c) network constraints at IEM level. Consistency between the separate implementations of these three components of the short-term signals is needed to avoid efficiency distortions¹¹.

Long-term signals (recovery of network costs and siting of new facilities). Network cost recovery at national level will be basically achieved by the application of national tariffs to the domestic network users and, thus, long-term signals can be

⁹ Network constraints may result from very different physical phenomena, such as thermal limits of transmission lines, unacceptable deviations from prescribed voltage conditions and avoidance of different types of instability conditions of the power system as a whole or for specific regions. “Network congestions” strictly applies only to some of the possible network constraints, but it is now commonly accepted in most documents related to the Florence process and also in the literature on transmission regulation that “congestion management” and “network congestions” encompass all kinds of network constraints, so this report will follow suit.

¹⁰ See [Schweppe et al, 1988], for instance. These are the market prices with time and locational differentiation that are used in systems such as Chile, Argentina, New Zealand or PJM in the US.

¹¹ [Rivier et al, 1993] provide the theoretical background for this statement.

provided by varying the contribution of network users to fixed costs according to their location. A reduced fraction of transmission costs may be partly recovered by the application of nodal pricing, zonal pricing or congestion management mechanisms at national or regional level. In addition, economic compensation mechanisms between countries –because of the costs that are incurred by cross-border transactions and loop flows— will increase or reduce, —again, this will typically be a reduced fraction of the total cost—, the total network costs to be recovered at national level.

Note that the revenues of the transmission network owner are typically fixed by regulation. Therefore no extra revenues should accrue to the Transmission System Operators because of the credits or charges that may result from congestion rents or inter-TSO payments. These amounts should be fully transferred to the domestic transmission tariffs.

B. The local G and L transmission tariffs provide access to the entire IEM

The network users in the countries participating in the IEM will have access to the entire IEM transmission network by just paying the local transmission network charge, —G for generators and L for consumers—, that corresponds to the country where they are located. This is a direct consequence of the “single system paradigm” principle, see Annex 2, since only one transmission tariff should be applied to the network users of a single market.

Several observations have to be made to the “G and L rule”. In the first place, each country may decide to apply some kind of geographical differentiation to its G and L tariffs. In the second place, the G and L tariffs of the different countries may differ widely, because of a variety of reasons, see Annex 4, and some degree of harmonization may be required. Finally, the original G and L tariffs will have to be somewhat modified, because of the compensations and charges that result from the adopted scheme of inter-TSO payments.

C. Economic compensations¹² among countries because of the costs incurred by cross-border transactions and loop flows

A mechanism will be established to compensate those countries that incur into extra costs because of cross-border trade, while at the same time the mechanism charges those countries that are responsible for these costs. Therefore, there will be no cross-border tariffs, but a compensatory scheme at country level¹³. Since the local, —at TSO or country level—, transmission tariffs for generators (G) or loads (L) will basically provide access to the entire IEM transmission network, the net outcome of the compensatory mechanism will result in some changes to the local transmission tariffs in the different countries.

¹² In the context of the Florence Forum these compensations have been named “inter-TSO payments”, since the basic entities that will be receiving and paying for these compensations are the Transmission System Operators (TSOs), which will have to reflect the net balance of compensations and payments as a credit or debit in their corresponding regulated transmission costs.

¹³ Most IEM countries have a single TSO, but some have several and these rules must be applied at TSO level. In this document country and TSO will be used without any distinction.

The compensations are required because of two reasons: a) losses that take place in a country because of the existence of cross-border transactions and loop flows; b) utilization of the networks of other systems because of cross-border transactions and loop flows. Compensations for network utilization will apply to new investments and “appropriate levels of the existing network”, since regulators may establish some limits or thresholds on the compensations that are derived from existing transmission facilities¹⁴.

Therefore the compensatory mechanism consists of three basic steps: i) determination of the *compensation* that is due to each country because of the costs that are incurred by cross-border transactions and loop flows; ii) determination of the *charges* that each country has to pay in order to compensate others; iii) a method to reflect the results of the two previous steps in the national tariffs G and L.

One may wonder why losses, —which should be a part of the short-term locational signals that should be sent to achieve an efficient operation—, are included in the long-term compensation mechanism. The reason is one of pragmatism. Typically the locational component of losses is weaker than that of congestions. Besides, establishing a common method to account for loss factors at IEM level appears to be unfeasible for the time being, given that many countries do not even take losses into account in their domestic markets. The pragmatic solution, therefore, is to leave only congestions for the short-term signals in operation and to include an annual compensation for losses into the long-term mechanism of inter-TSO payments. In this way, at least the countries are compensated because of the effects that cross-border transactions and loop flows have on their networks. Even if no economic signals are sent in the short-term.

D. Use of real network flows

Transmission network flows behave in a complex manner, according to physical laws and the topology of the network. Endless and fruitless discussions are the typical outcome of the adoption of methods that oversimplify physical reality, therefore exposing themselves to contradictions and justified claims of biased behavior. This is the case of the provisional method that was implemented on March 1st 2002.

Unless models with “real network flows” are employed, —i.e. models that represent all the existing transmission lines with their actual metered physical flows—, it will be impossible to properly reflect the reality of the functioning of the power system, such as the relative directions of transits and internal flows in a country or the loop flows that take place even without net exports or imports. These features have to be incorporated into the model so that the results cannot be considered to be arbitrary.

¹⁴ The use of thresholds or limits to compensations on existing lines will find a justification when too crude or even arbitrary methods are employed in the computation of inter-TSO payments, so that unreasonable economic transfers are avoided. The better the representation of the reality of network utilization the lesser the need to introduce thresholds or discrimination between the treatment of existing and future lines.

E. Treatment of existing and future lines

A method that treats existing and future transmission facilities in the same way is simpler to understand and to apply and, in principle, should be preferred. It is obvious that the “future lines” of today will become “existing lines” some years from now. If the procedures to deal with both categories of lines are different, it will be necessary to keep track of which group each line pertains to, in all future calculations. This is messy, although it can certainly be done.

This is clearly an open issue that requires a regulatory input and, as it was indicated before, the decision may be linked to the level of satisfaction with the procedure of determination of the inter-TSO payments. In any case, any sound decision should be based on the knowledge of the magnitude of the compensations and charges that would result from a scheme that is based on some measure of network utilization and losses, such as the methods that are examined in this report.

F. Standardized costs

Another regulatory problem that must be faced is to go from the network utilization factors that are provided by some suitable algorithm to the economic compensations and charges that are required by the inter-TSO payment scheme. The point here is that it is not acceptable that the costs to be compensated in the different countries respond to widely different regulatory practices that result in totally disparate unitary costs of otherwise similar facilities.

The inter-TSO payments scheme, because of its very own nature, demands that the costs of the networks of different countries be shared by other countries. But one can understand the reluctance of a country M to pay a fraction of the cost of the network of another country N , where such a cost has been determined following regulatory practices that are not acceptable to country M . And the reluctance increases if it happens that the regulated per unit cost of a facility in country N (e.g. the cost of 1 km of single circuit line of 400 kV) is much higher than the per unit cost of the same item in country M . Unfortunately, these important differences in regulatory practices and per unit costs within the IEM countries are not only hypotheses but actual facts, as it has been shown in a recent study on benchmarking of transmission tariffs in the IEM countries, see [Pérez-Arriaga et al, 2001].

Therefore, it seems that the only acceptable way to share costs of other existing networks is to establish a common standard of costs for each transmission component (e.g. 1 km of double circuit line of 220 kV or 1 kVA of a 400 kV/132 kV transformer). These standards should be based on the actual values that are currently accepted by the regulators of the IEM countries, so that it is avoided a theoretical discussion on the costs that are more adequate for this purpose, e.g. replacement versus historical costs.

The determination of the costs to be shared of future “cross-border-lines” is easier. One possibility, in case the construction of the lines is assigned by a competitive bidding process, is to accept the cost of the winning bid, since it is the result of an open and competitive procedure. Another possibility is to establish a set of common standards of cost for each type of facility. In this case the cost should be the present replacement cost of the transmission asset, and it could be determined from

information requested from firms that construct, operate and maintain transmission facilities.

G. Non transaction-based charges

Any charges that may be derived from the inter-TSO payments scheme, because of their intrinsic nature of long-term economic signals, must not depend on the specific commercial transactions among the market agents¹⁵. Therefore they must be only related to the point of connection, the nature of the agent and the time profile of the input or output of power.

H. Locational signals

The inter-TSO payment mechanism that has been adopted in the Florence Forum may also play a role with respect to sending correct locational signals. However, one has to acknowledge that inter-TSO payments are primarily meant to compensate economically those countries whose networks are being used by external users and not as a means to send precise locational signals to the individual agents of the market, even though inter-TSO payments in the end will result in a correction to the local G and L charges. This means that other mechanisms are needed in this respect.

This philosophy of not placing the emphasis of inter-TSO payments on locational signals is consistent with the fact that the differences in transmission tariffs among the IEM countries are presently large enough to overcome the estimated impact that the inter-TSO payments could have on the G and L tariffs, see Annex 4. A recent benchmarking study on transmission tariffs [Pérez-Arriaga et al, 2001] indicates that, for a typical large consumer (demand of 15 MW from 8 am to 24 pm on week-days), transmission tariffs in IEM countries could range between 3.5 and 14 €/MWh. It should be noted that the average integral tariff for these consumers in the IEM is in the vicinity of 45 €/MWh. Preliminary values for compensations (before netting them out with charges) that were proposed by the European Association of System Operators (ETSO) would result in an average value for all countries in the IEM in the range of 0.2 €/MWh, with a couple of countries with values as high as 0.5 €/MWh and 1.8 €/MWh. Therefore, one may conclude that harmonization of the current national transmission tariffs, -and the G charges in particular-, must be given priority over trying to use the inter-TSO payment scheme for sending EU-wide transmission-related locational signals.

Some additional remarks are pertinent here. The first one is to realize that the methods of network cost allocation that will be examined in the next chapter *compute precise pan-European transmission network nodal tariffs* before aggregating them into inter-TSO payments. Therefore it is not the lack of knowledge or information that prevents us from computing and applying transmission tariffs that incorporate precise locational signals. However, , —at least for the time being—, these detailed nodal charges are merely used to compute inter-TSO payments in the proposed aggregate format. Depending on how the net inter-TSO payment for each country is internally allocated, the initial correct nodal

¹⁵ See Annex 2 for a more detailed justification.

long-term locational signals may be partly lost. In most cases, at least the geographical differentiation within the country will disappear, once the charge has been aggregated at country level. From a wider inter-country perspective, the issue is the relevance of the corrections that result from the inter-TSO payments when compared to the existing differences between the regulated transmission tariffs in the different countries, a point that has just been commented.

All this may result in a temporary deficiency of clear long-term locational signals in the installation of new generation or load facilities in the IEM network¹⁶. While national transmission tariffs are uniform domestically and they present large differences between countries, mostly due to “regulatory noise”, it may not help much to try to add some comparatively small locational signals to them.

The possible insufficiency of long-term locational signals, —for the time being—, in the transmission network tariffs does not mean the absence of locational network signals. Strong short-term locational signals exist in the model for implementation of the IEM that has been proposed in Florence, as a result of the proposed pan-European schemes of congestion management.

And finally, it should also be realized that inter-TSO payments may correctly reflect, —although in an aggregated way at country level—, the allocation of the costs of new network investments to the agents that make use of them. This is very important when devising regulatory procedures of promotion of future network investments.

2.1.2 The provisional mechanism

The provisional mechanism was proposed by ETSO and implemented by March 1st, 2002. It is intended to be in operation until January 2003. In this mechanism the inter-TSO compensations are a function of the transit hosted by each country or TSO as measured from the flows on the interconnections with the adjacent countries or TSOs. The charges to recover the compensation fund combine two models: “declared exports” and “net-flow”. Room is left for subsidiarity in the design of details.

The basic steps in the implementation of the provisional mechanism are the following ones:

1. ***A fixed compensation fund of 200 million euro for the year 2002.*** The amount of 200 M€ obtained regulatory approval at the Florence Regulatory Forum. This compensation fund is divided in two parts. The estimation for each part is calculated ex-ante from “last-year” data defined for the first year from July 1st 2000 to June 30th 2001. The estimation for each part of the fund is required to enable each TSO to calculate the impacts to national tariffs through which the contribution is collected.

¹⁶ It is important to realize that this does not prevent the TSOs and regulators from proposing and authorizing adequate network reinforcements. The economical and technical analyses that are needed to justify a new transmission investment can be done regardless of the lack of precise locational signals for the network users.

A first part (called “declared export”) of the fund is calculated by applying a payment of 1€/MWh to the estimated volume of declared exports in 2002. This estimated volume of declared exports is based on the arithmetic mean between the declared exports (following UCTE rules) and the net export flows (considered as ideal netting).

The second part (called “net flow”) of the fund is defined as the remaining amount of contribution to collect so as to obtain the total fund. In this context, “Net Flow” is defined as the country net flow in export and import directions (measured hour by hour). In order to determine the contribution of each TSO in the “net flow” fund, the model “net flow” using “last year” data is applied for each country (for countries with more than one TSO, the internal distribution is to be agreed between the concerned TSOs).

2. *The contribution of each TSO to the fund* is made of:

- a contribution resulting from applying 1 Euro/MWh to “UCTE declared exports” (expected to cover the TSO contribution to the “declared export” part of the fund). The precise design of the charge recovery by individual TSOs is left to the decision of this TSO and its Regulating Authorities. Nevertheless, this charge recovery must be in the spirit of getting a fee from those market participants having the responsibility of export flows.
- a contribution resulting from the L part of the national tariff (expected to cover the TSO contribution to the “net-flow” part of the fund). This fund would be raised through socialization in output fees (Ls) in the national tariff of the different countries.

The provisional approach that has been proposed by ETSO has the obvious advantage of ending the undesirable system of pancaking of transmission tariffs that is currently prevalent in the IEM. However, it presents the following important shortcomings:

- *Compensations.* The total amount of compensations should be based on a more objective procedure. The figure of 200 M€ is not reliable. The allocation key that determines the compensations in the provisional mechanism is easy to compute but it is flawed, as it for instance does not take into account the direction of the transits with respect to the internal use of the network. The allocation key in the permanent mechanism should account for the actual configuration of physical flows and the impact of cross-border transactions and loop flows on the network utilization and losses of the different systems. EU-wide standard transmission costs should be used to compute the economic compensations and charges, rather than the costs that are submitted by each country.
- *Charges.* The allocation of charges should be entirely based (and not only 50% based, as in the provisional mechanism) on imports and exports, taking locational factors into consideration. In the provisional mechanism 50% of the charges are based exclusively on the volume of exports. Perimeter countries are also charged on the basis of exports. One can notice that the allocation of

charges is totally unrelated to the allocation of compensations. A sound algorithm of network cost allocation should be able to compute compensations and charges on the basis of the same principles.

- *Application to internal tariffs.* The modifications to the local G and L charges resulting from the inter-TSO payment scheme should be based on the net balance of compensations and charges in each country (*still under discussion; maybe different allocation criteria could be applied to each part*). The provisional mechanism applies a specific procedure to the charges and leaves open the treatment for the compensations. At least it should be made sure that no compensation payments go to the TSOs as additional income; they should be used to reduce the tariffs. Besides, the rules of application of the charges to the internal users in the provisional mechanism are arbitrary and transaction-based. It is not clear why the “net flow” part has to be charged only to consumers. The application of the “declared exports” charge to exporting generators is tantamount to an export fee. Although some room could be left to subsidiarity here, the modification of the G and L charges must follow guidelines that must be derived from sound transmission pricing principles.

What is desired is an allocation mechanism that is seen as fair and that is easy to understand and to apply, given that the inter-TSO payment mechanism is not meant, —as it will be seen later—, to move very large amounts of money. But, on the other hand, it is not desired an algorithm that presents obvious flaws and that therefore can be easily contested, as it is the case with the allocation key that has been proposed by ETSO for the provisional inter-TSO payment approach (see Annex 3).

Most of the shortcomings of the provisional mechanism could be solved if sound methods of network cost allocation, —both for losses and network utilization—, in the regional context of the IEM could be available. The design and test of such methods is the main purpose of the present study.

2.1.3 The long-term mechanism

Because of the shortcomings of the provisional mechanism, it was decided to replace it on January 2003 by a long-term mechanism that makes full use of the principles that have agreed at the Florence Forum and that have been presented above in section 2.1.1.

The long-term mechanism starts from the local G and L charges that are determined by the different countries for their generators and consumers, respectively, probably subject to some harmonization criteria, see section 2.2. below. The major task that the long-term mechanism has to address is the definition of a “satisfactory method” to determine the economic compensations that are due to a country, —and the corresponding charges to other countries—, because of the costs that are incurred by cross-border transactions and border flows. These costs have been already identified as being the costs of losses and the costs derived from network utilization, which could be subject to some limits or thresholds by the regulators. Once the compensation and the charges that correspond to any given country are computed, the results should be applied to modify the original G and L

charges in some cost reflective, —and also probably harmonized—, manner, so that the locational signals at country level are properly placed.

The search for this “satisfactory method” brings us back to the basic problem of transmission pricing: How should the network costs, —and here we refer to the costs of the networks of the 17 countries participating in the IEM—, be allocated? In the Florence Forum the pragmatic approach of network cost allocation that is based on “electrical utilization” has been implicitly adopted, mostly because of the fact that it does not appear to be other viable alternative for a problem of the size and complexity of the network of the IEM¹⁷.

There are, however, several ways to evaluate “electrical utilization” and they will be discussed later in chapter 3. Here it will be assumed that a satisfactory allocation method, the “network cost allocation method” exists and will be used for the task at hand. It has been agreed that the method should be based on actual network flows in the IEM network. Obviously the consideration of a certain number of scenarios will be needed so that the reality of the functioning of the IEM system can be properly represented.

According to the cross-border tarification principles that have been adopted in Florence, —see section 2.1.1 above—, the prototype algorithm for network cost allocation must have the following basic features:

- For any given country j , the algorithm must be able to determine the fraction of network utilization and the fraction of losses that should be assigned to external use, that is, cross-border transactions and loop flows. This is the essential information to compute the compensation that is due to country j .
- The algorithm must also be able to assign the responsibility of the compensation of country j to all the remaining countries. This is the essential information to compute the charges for each one of the countries.
- The computations to determine compensations and charges should be based on physical flows in real flow network models.
- The algorithms will not make any distinction between existing and future transmission facilities.
- Determination of the economic value of compensations and charges should be based on standardized costs of transmission elements and of the per unit cost of energy losses.
- The net results of the compensation and charges for any given country j should be transferred to the domestic transmission tariffs G and L , in a non transaction-based manner.

¹⁷ Annex 2 on transmission regulation discusses alternative options of network cost allocation.

2.2 Network tariff harmonization

The responsibility for setting local tariffs corresponds to the national regulatory authorities but, in order to avoid distortions in the functioning of the IEM, some level of harmonization will be required regarding:

- The split of total network costs between G and L charges.
- The split of each tariff into an energy and a capacity component.
- The application of the net result of the compensation and charges for each country, —i.e. the net inter-TSO payment—, to its network users.

Any harmonization proposal must start from a recognition of the fact that the level and the structure of the transmission tariffs vary widely within the IEM countries. Although objective factors —such as the size of a country, its total electricity consumption or the intensity of this consumption—, justify that the levels of national tariffs should be different, regulatory factors that are very difficult to harmonize are also very influential in the level of the tariffs¹⁸. The tariff structures in the IEM also differ much in the allocation of the charges to energy or capacity terms, or to generators or consumers, as well as regarding time or geographical differentiation.

In this climate of diversity any harmonization proposal has to be pragmatic and to establish clearly the priorities. Avoidance of market distortion, —this concerns mostly the charges to generators—, should be the first objective, rather than trying to achieve a complete tariff harmonization. If it is not possible to achieve convincing pan-European generator charges, then the objective should be to minimize market distortions. To this effect, these guidelines could be followed: a) charge mostly to consumers, as this is also what the inverse elasticity pricing rule would require in a competitive market; b) establish a playing field as level as possible for generators; c) if charges to generators at IEM level are not to be trusted, then use preferably capacity charges, as these do not immediately interfere with the short-term market behavior.

Some of the algorithms that will be presented in chapter 3, —in particular those that are based on determining the network utilization of individual agents—, can be of much help in providing information on fully harmonized pan-European nodal transmission tariffs or on how to modify the local G and L tariffs because of the existence of inter-TSO payments.

2.3 Congestion management

Guidelines for the development of a comprehensive solution to the problem of congestion management at IEM level have been proposed by the Council of European Energy Regulators (CEER) and the Florence Forum has issued some general recommendations. The Association of European Transmission System Operators (ETSO) has proposed a coordinated congestion management scheme that seem to comply with the regulatory guidelines. Much implementation work

¹⁸ See [Pérez-Arriaga et al., 2001] and Annex 4.

remains¹⁹. This topic is not developed in more detail in this report, since it is beyond the objectives of the present study.

2.4 Transmission network investments²⁰

The adequacy of transmission network infrastructures is critical for the success of the implementation of the IEM. Presently, several systematic bottlenecks prevent that all Member States may participate fully in the IEM.

In the development of new transmission investments, priority should be given to proposals of “cross-border reinforcements”²¹ that are:

- presented by TSOs (individually or jointly) and belonging to a systematic plan,
- authorized by the involved regulators and some type of “experts commission” (mostly composed of ETSO delegates) that examines the implications of the proposed reinforcements at EU level,
- included in the inter-TSO payment scheme, so the costs are properly shared among the users.

Merchant lines, —i.e. lines that are not subject to the usual procedures of remuneration of regulated monopolistic activities—, should be allowed, but only

- after “TSO planned lines” have been given priority,
- if they are not included in the plans of the TSOs or, even if they have been included, they are not built for some reason,
- if they provide open access (at a market price) to all agents under no discriminatory conditions.

Merchant lines will be exposed to the risk that existing congestion rents may disappear because of the installation of new network investments. It seems therefore fair that revenues of merchant lines should not be limited by the regulators during the prescribed duration of the license.

¹⁹ The corresponding documentation can be examined at the web sites of the aforementioned institutions.

²⁰ Specific guidelines have not been issued yet at the Florence Forum. The material in this section reflect the personal opinion of the authors of this report.

²¹ In general all network investments should receive the same regulatory treatment, but these rules have particular importance for those lines that have a significant utilization by cross-border transactions and loop flows.

3 A critical review of methods for determination of cost components in cross-border exchanges of electricity

This chapter conceptually examines different alternatives to determine the compensations and charges that should be applied to the different countries in the IEM because of the costs incurred by cross-border transactions and loop flows.

Following the guidelines that have been established in Florence, the review of methods will be split into two blocks. On one hand the methods that deal with network infrastructure costs. On the other hand the methods for allocation of network losses. Obviously some of the methods in the two categories have many points in common.

3.1 Compensations and charges due to utilization of networks by cross-border transactions and loop flows

Many approaches and algorithms for transmission pricing have been proposed in the technical literature and many have been implemented in the regulatory practice²². However, no transmission pricing method has been considered yet to be entirely satisfactory, even at the single country level.

Economic reasoning leads to search for a method of network cost allocation that is based on the *economic benefits* that each network facility provides to the different agents²³. Or, if the approach of looking for “incurred network costs” is adopted, one may try to take the perspective of a greenfield transmission network planner, and look for the *responsibility of each agent in the development of the existing network*. However pragmatism, when considering that any proposed scheme has to be applied within the demanding regional context of the IEM, dictates the adoption of approaches that are based on the *electrical utilization* of the networks. This is the attitude that has been adopted in the Florence Forum.

Therefore we shall start by accepting that the “utilization” of a network by external agents is an acceptable measure of the costs of infrastructure that are born by this network because of cross-border transactions and loop flows. But we must know from the outset that a precise definition of “electrical use” does not seem to be possible, since electricity flows cannot be tracked down as a fluid in a pipe. The best we can do for the time being is to devise an algorithm that is compatible with sound engineering and economic principles, that is simple to understand and intuitive, whose results make economic and engineering sense and that is able to pass the difficult test of providing reasonable results in all circumstances. This is of

²² See [Utilities Policy, 1997], for instance.

²³ See Annex 2 for an explanation.

utmost importance to endure the potential criticisms of those parties that may feel to be negatively affected, as indicated before.

Let us examine now in more detail what is meant by “electrical utilization”. Underlying the idea of network utilization is the pretense of knowing the source and the destination of the power flows. Methods such as the method of **average participations**²⁴, —that was used for instance in New Zealand more than ten years ago, but also in South Africa, Poland and in diverse technical studies in Latin America, Switzerland or Norway—, appear to provide a very promising solution to the problem of tracking the flows while totally ignoring political borders. It has been argued that the rule for tracking the flows is just a reasonable heuristic, which is a fair statement. It has been also pointed out that totally ignoring the political borders, —which is a direct consequence of the “single system paradigm” and the principle of non-transaction based network charges—, may cause that the resulting network utilization factors can be adverse for relatively small countries with large transits, since these countries may appear to participate excessively in the utilization of external networks. In case that this is considered to be a valid objection to the method, —either permanently or transitorily—, a suitable modification to the standard average participations algorithm has been devised, which can eliminate this feature of the algorithm.

Another family of network cost allocation methods is based on the concept of **marginal participations**, i.e. the marginal changes in all the network flows that are caused by a marginal increment of the generation or the load at any given node. This approach has been used for many years in Chile, Argentina and other Latin American countries. It uses marginal quantities that obey to the laws of physics, but it runs into other type of difficulties. The algorithm needs the specification of what is called a “slack node” or reference node, which responds at the margin to any modification in generation, demand or power flows in any part of the system. The problem here resides in the arbitrariness of the selection of the slack node and also in the idea of considering that the use of the network is based on “bilateral transactions” rather than being “nodal based”, which appears to be more suitable for the long-term signals of transmission tariffication. Different selections of the “slack node”, —a change in the location, a distributed virtual node so that all the demand responds pro rata, idem with the generation—, lead to widely different results²⁵, at least from the point of view of calculating inter-TSO payments, but making some choice is unavoidable. The utilization of marginal participations in the evaluation of network usage has other shortcomings that will be described later.

The transmission pricing approach that has been adopted in the UK and Colombia, -whose implementation has many points in common with MP-, is based on the search of the responsibility of generators and consumers in the network investments, which is a very sound concept and may constitute a valid approach for determining long-term locational signals. However, this is a very demanding task, and the resulting ICRP (stands for Investment Cost Related Pricing) method is an

²⁴ See for instance [Utilities Policy, 1997], [Rubio et al., 2000], [Bialek, 1996] or [Kirschen et al, 1997].

²⁵ As shown later, a change in the slack modifies the network utilization factors in some coordinated ways that can be taken advantage of.

oversimplified version of a true transmission planning model that, -from the point of view of determining inter-TSO compensations-, runs into exactly the same problem of selection of a reference node as the method of marginal participations. The impact of the choice of the reference node may be acceptable when dealing with transmission tariffs at country level, but its application seems to be too controversial in a regional market that comprises 17 countries.

A different approach is to avoid looking for the individual network charges of each generator and consumer in the IEM and to determine the compensations and charges for each country that are needed to compute the inter-TSO payments directly. The computation of compensations and charges would be also based on suitable measures of network utilization, looking for the changes in the network flows that take place when the “external use” of the network of any given country is removed. This family could be termed the “**with and without**” approach and it has been recently adopted by NORDEL for the allocation of losses between their members. The idea is intuitively appealing and it is grasped immediately. The difficulties appear in the details of the implementation. First of all it is needed to define “external use”, and the ambiguous concept of “transit” has to be introduced. Then the idea is to compare the volume of utilization of the network of the considered country with and without externally induced flows or transits. Again, some measure of network utilization, such as the total amount of MW x km has to be defined, but different interpretations in the computation of the difference may arise. Then there is need to make another extra assumption, since it is necessary to invent a new situation (the “without-transit” case) that does not correspond to reality, since the only existing and unquestionable reference case is the one with the actual power flows. Since “the devil is always in the details”, the fact that these extra assumptions are needed could make the procedure prone to be rejected on the basis of the arbitrariness of the choices that necessarily have to be made.

Based on the above considerations, as well as on the specific proposals that have been recently examined at the Florence Forum, this report has chosen for examination six different methods, which could be grouped into two major families:

Family 1: Based on the network utilization of individual agents and complete actual cross-border flows.

- Algorithm 1: Average participations (**AP**).

This is the classical average participations algorithm.

- Algorithm 2: Simplified average participations (**SAP**).

The AP algorithm is applied to a simplified model of the IEM network, where each country is represented by a single node.

- Algorithm 3: Modified average participations (**MAP**).

It is meant to eliminate the external network use of those countries that are internally balanced in generation and demand, even though they may have transits. The external network use of a country j is then determined by collapsing its network into a single node with the balance of its total generation

and demand. The network and flows outside country j are left intact. Then the AP algorithm is used to evaluate network participations.

- Algorithm 4: Marginal participations (**MP**).

Only some test cases have been run in order to demonstrate the mechanics of the method and the effect of the choice of the reference node.

Family 2: Based on the impact of transit flows on each considered country

- Algorithm 5: With & without transit method (**WWT**).

This is the direct approach of defining the transit for each considered country j , then creating a situation without the transit in country j and finally comparing the network utilization in country j in the two situations.

- Algorithm 6: Average participations applied to transits (**APT**).

Instead of creating the “without transit” situation, the AP algorithm is used to track the transit flows (defined as in the WWT algorithm) and evaluate its impact on each considered country j .

In the following subsections this report describes and then critically examines each one of these algorithms and also discusses their strong and weak points, conceptually. The numerical evaluations and comparisons are left for chapter 5.

Family 1: Algorithms that are based on the network utilization of individual agents and complete actual cross-border flows

Before starting the presentation of each one of the algorithms in this family, we shall specify which are the desirable properties of a prototype algorithm for allocation of infrastructure network costs that is based on electrical utilization. This will help us later in the critical evaluation of the alternative methods.

The prototype network cost allocation algorithm

The ultimate goal of a cost allocation algorithm for use in the inter-TSO payments scheme is to allocate the cost of the transmission network of a country among all countries, obviously including itself. As it was discussed before, here it will be accepted that the “utilization” of a network by the agents is a suitable criterion for cost allocation.

Assume a sound algorithm for allocation of use of networks, —“the network cost allocation algorithm”—, exists and has been adopted. Now, equipped with the “network cost allocation algorithm” and the description of the actual electricity flows in the IEM network for a specific scenario (i.e. operating condition), one can assign the utilization of every transmission line in each one of the 17 countries of the IEM to the users located in a certain number of nodes, which typically will not be too far away from the considered facility, although this obviously depends on the prevalent flow patterns, see Figure 1. The exercise will have to be repeated for the set of scenarios that can be considered to reasonably represent the IEM network utilization during the considered time period (typically one year).



Figure 1: Allocation of the use of a transmission line²⁶

The procedure above, if applied to the entire network of the 17 IEM countries ignoring political borders and, if the cost of each line could be somehow given, would provide individual transmission tariffs for the users in every node of this network. That would be an IEM global transmission tarification mechanism, and one which provides complete locational signals, but it can be also used to determine inter-TSO payments.

How can we use the results of the algorithm in the context of the inter-TSO payment mechanism, as described above? It is very simple. We have to remember that, according to the Florence's conclusions, "there will not be cross-border tariffs, but inter-TSO payments, whose net result for each country will be used to modify its local G and L charges". Assume that a country M has 600 lines, that 80% of the use of line 1 of country M has been allocated by the algorithm to nodes within country M , 15% to nodes in country N and 5% to nodes in country P . Same thing with line 2, with different percentages, and then with line 3, line 4 and so on, until all 600 lines have been accounted for. It is then immediate to compute the fraction of the entire network of country M that is used by its local users and how much is used by users in country N , country P and so on²⁷. If we attach standardized costs to the individual lines, then we automatically obtain the total economic compensation that is owed to country M and also how much of it must be paid by country N , country P and so on.

²⁶ This is a symbolic representation that does not correspond to any actual line

²⁷ It would not be correct to give the same weight to all lines, regardless of their voltage and length. The best weighing factor for the computation of inter-TSO payments is the individual standardized cost of each line.

Note that the transfer of money among countries is the same with the inter-TSO mechanism that has been just described as with a fully detailed global IEM tariffication system at nodal level. The only difference is that in the later procedure the compensations that must be paid by external users are directly charged to individual network users, while in the former procedure the charges that correspond to the users of a country (or TSO) are passed to the country as a whole, to be later allocated internally in some fashion. Is this simplification acceptable? Certainly, since most countries use uniform tariffs (postage stamp rates) and therefore it makes no sense to use locational differentiation with the external compensations only. In other cases they use their particular form of locational differentiation, which may not be compatible with individualized nodal charges resulting from an IEM network.

This prototype algorithm for the determination of the fraction of a network that needs to be compensated by external users, also computes the percentages of each compensation that must be attributed to every external country automatically. This has been shown above to be a part of the general procedure. This method correctly and implicitly takes into consideration the import and export flows, as well as any geographical consideration. Therefore there is no need to design a new allocation algorithm to determine the charges. Compensations and charges are computed at the same time.

Table 1 below is a sample of the kind of results that can be obtained by application of the prototype algorithm to a single scenario of the UCTE network, comprising 17 countries in continental Europe (see Chapter 4 for details)²⁸. It follows the explanation of the elements of the table.

	E	P	F	I	CH	D	B	NL	SLO	A	CZ	PL	BIH	HR	H	SK	UA			
E	10.43	0.11	0.19	0.00	0.00	0.00	0.00	0.00	0.00	0.00	0.00	0.00	0.00	0.00	0.00	0.00	0.00	10.73	0.30	
P	0.19	2.01	0.00	0.00	0.00	0.00	0.00	0.00	0.00	0.00	0.00	0.00	0.00	0.00	0.00	0.00	0.00	2.20	0.19	
F	0.16	0.00	29.26	0.40	0.33	0.45	0.13	0.00	0.00	0.00	0.00	0.00	0.00	0.00	0.00	0.00	0.00	30.74	1.48	
I	0.00	0.00	0.34	11.29	0.49	0.01	0.00	0.00	0.02	0.05	0.00	0.00	0.00	0.10	0.01	0.00	0.00	12.31	1.02	
CH	0.00	0.00	0.15	0.24	2.60	0.19	0.00	0.00	0.02	0.00	0.00	0.00	0.00	0.00	0.00	0.00	0.00	3.20	0.60	
D	0.00	0.00	0.04	0.00	0.22	22.46	0.01	0.30	0.00	0.20	0.08	0.09	0.00	0.00	0.00	0.00	0.00	23.40	0.94	
B	0.00	0.00	0.15	0.00	0.00	0.01	2.06	0.08	0.00	0.00	0.00	0.00	0.00	0.00	0.00	0.00	0.00	2.30	0.24	
NL	0.00	0.00	0.00	0.00	0.00	0.23	0.08	1.58	0.00	0.00	0.00	0.00	0.00	0.00	0.00	0.00	0.00	1.89	0.31	
SLO	0.00	0.00	0.00	0.01	0.00	0.00	0.00	0.00	0.22	0.06	0.00	0.00	0.00	0.03	0.00	0.00	0.00	0.31	0.10	
A	0.00	0.00	0.00	0.00	0.04	0.06	0.16	0.00	0.00	0.03	1.15	0.02	0.00	0.00	0.00	0.02	0.01	0.00	1.49	0.35
CZ	0.00	0.00	0.00	0.00	0.00	0.25	0.00	0.00	0.00	0.07	1.28	0.04	0.00	0.00	0.00	0.06	0.00	1.71	0.43	
PL	0.00	0.00	0.00	0.00	0.00	0.05	0.00	0.00	0.00	0.00	0.07	6.54	0.00	0.00	0.00	0.04	0.00	6.70	0.16	
BIH	0.00	0.00	0.00	0.00	0.00	0.00	0.00	0.00	0.00	0.00	0.00	0.00	0.21	0.02	0.00	0.00	0.00	0.23	0.02	
HR	0.00	0.00	0.00	0.03	0.00	0.00	0.00	0.00	0.05	0.01	0.00	0.00	0.08	0.28	0.02	0.00	0.00	0.47	0.20	
H	0.00	0.00	0.00	0.01	0.00	0.00	0.00	0.00	0.01	0.01	0.01	0.00	0.00	0.01	1.00	0.07	0.02	1.13	0.13	
SK	0.00	0.00	0.00	0.00	0.00	0.00	0.00	0.00	0.00	0.01	0.03	0.05	0.00	0.00	0.05	0.95	0.01	1.10	0.15	
UA	0.00	0.00	0.00	0.00	0.00	0.00	0.00	0.00	0.00	0.00	0.00	0.00	0.00	0.00	0.02	0.04	0.01	0.08	0.06	
	10.73	2.12	30.13	12.02	3.71	23.80	2.28	1.96	0.33	1.58	1.48	6.72	0.29	0.44	1.13	1.17	0.05			
	10.73	2.20	30.74	12.31	3.20	23.40	2.30	1.89	0.31	1.49	1.71	6.70	0.23	0.47	1.13	1.10	0.08			
	0.05	-0.08	-0.61	-0.29	0.51	0.40	-0.02	0.07	0.01	0.09	-0.22	0.02	0.06	-0.04	0.01	0.07	-0.03			
	0.35	0.11	0.87	0.73	1.11	1.34	0.22	0.39	0.11	0.44	0.21	0.18	0.08	0.16	0.13	0.22	0.03			
	0.30	0.19	1.48	1.02	0.60	0.94	0.24	0.31	0.10	0.35	0.43	0.16	0.02	0.20	0.13	0.15	0.06			

Table 1: Case example of participations of network use.

²⁸ In the table E stands for Spain, P for Portugal, F for France, I for Italy, CH for Switzerland, D for Germany, B for Belgium, NL for The Netherlands, SLO for Slovenia, A for Austria, CZ for the Czech Republic, PL for Poland, BIH for Bosnia, HR for Croatia, H for Hungary, SK for the Slovak Republic and UA for Ukraine.

All numbers in the table are percentages of the total equivalent number of lines of 400 kV in the considered UCTE network. For instance, 10.43 means 10.43% of the total number of lines in the considered model²⁹. If the numbers in any given column, for instance column *F* for France, are considered:

- 0.34 is the external use made by *I* (Italy) of the French network.
- 29.26 is France's own utilization of its network.
- 30.13 is the total use of the French network (both by France itself and by others), i.e. the total volume of lines in the French network, and it is equal to the sum of all numbers in the column above.

Consider now the numbers in row *F*, again for France:

- 0.33 is how much France uses the Swiss network.
- 30.74 is the total use of France of the European network, including the French network, and it is equal to the sum of all numbers in the row to the left. This number 30.74 has been repeated below 30.13 in column *F*.
- The difference between the two aggregate numbers: $30.13 - 30.74 = -0.61$, is the inter-TSO payment for France. As it is negative, France has to pay. This means that France uses other external networks more than other countries use the French network.

There are also other numbers of interest in column *F*, for France:

- The number 0.87 in column *F* is the sum of all external utilizations of the French network by others (0.19 by Spain, 0.34 by Italy, 0.15 by Switzerland, 0.04 by Germany and 0.15 by Belgium), excluding France's own use.
- Similarly, the number 1.48 in column *F* is a replica of the leftmost number in row *F*. This is the sum of all external utilizations that France makes of external networks (0.16 of Spain, 0.40 of Italy, 0.33 of Switzerland, 0.45 of Germany and 0.13 of Belgium).
- It should be clear by now that the difference between these two numbers: $0.87 - 1.48$ also equals the inter-TSO payment for France: -0.61 .

The prototype algorithm and the adopted approach to determine inter-TSO payments also have other interesting properties:

- Once the algorithm has been applied and the numerical results have been obtained, the regulators may adopt any rules concerning whether compensations

²⁹ The model has more than 3,500 lines. As explained in chapter 4, the reason for this peculiar way of presenting the results is that the length of each line has not been provided as an input data. Therefore, all lines have been assumed to have equal length and some standard equivalence factors have been employed so that 400 kV lines, 220 kV lines and transformers could be jointly considered. One 220 kV line equals 0.66 equivalent 400 kV lines, one 132 kV line equals 0.44 equivalent 400 kV lines and transformers have been sometimes considered as equivalent to 400 kV lines, or to 220 or even 132 kV lines.

will be applied to all countries or just to those who exceed a prescribed threshold of any given measure of external utilization. In this way a general rule would be applied in principle to all countries but, if so desired, the outcome would be executed only for the countries where it has a significant impact or because of some other reason.

- The procedure may help in the definition of what has been called the “horizontal network”. This is the network whose lines could be affected by cross-border flows or, in other words, the network formed by the lines whose utilization might correspond, up to a significant degree, to external users. The “network cost allocation algorithm” could help in finding out whether a particular line, group of lines or voltage level qualifies for belonging to the horizontal network. For this purpose the length of the itinerary that corresponds to the flow in any given line or group of lines can be determined. If the itinerary is too short then the line or group of lines probably do not qualify as a transmission line.
- The method can be equally applied to existing or future lines. This feature may have much practical importance when having to assess the allocation of costs of future network investments. Once the method has been implemented, the allocation of the costs of a future line to the countries that share its use is done automatically, as the new line is incorporated to the set of existing lines without any difference. Whenever a significant fraction of the responsibility in the utilization of the line (e.g. more than 5%) falls in network users that are external to the country, then the line might be considered a “cross-border line” (even if it physically lies entirely within a single country) and it might be regulated that the authorization process of the line should be decided by an institution at EU level, rather than only by the regulator of the country where the line is to be built.
- For any given country j , the prototype algorithm, as a byproduct of its computations, can directly provide the allocation key of the net inter-TSO payment for j to its internal tariffs G and L . The “network cost allocation algorithm” precisely determines how much the generators in country j are using of the network external to j , and also how much of the network of country j is being used by generators from outside country j . The excess of the first amount over the second one is the extra payment (or credit, if the amount is negative) that should be charged to the generators in country j . These locational signals are weaker than they should ideally be, since the average value for country j is used instead of the individual value for each generator, but this is in the nature of the inter-TSO payments approach. The same reasoning should be used for consumers.

3.1.1 Algorithm 1: Average participations (AP)

Background

The basic intuition behind the average participations method is that the sources of the supply to loads and the destination of the power injected by generators, as well as the responsibility for causing the flows in all lines, can be assigned by employing

very simple heuristic rules that only make use of the actual pattern of network flows. Although this procedure does not intend to capture the details of the physics of the problem, one could argue that, in an electricity market that works reasonably well, the power flows from nodes where it is less expensive towards nodes where it is more expensive. Thus, using the actual network flow pattern may be a way of assigning sources and sinks to loads and generators, respectively, in a reasonable and economically-meaningful manner. It is not the only possible way, but it is intuitive, and simple to explain and to compute.

The algorithm of average participations is simple and robust, and it uses as its basic input the data of historical or computed network flows, where there are obviously no simplifications, and the actual network topology. The method is based on a proportionality assumption, the inflows to a node are distributed proportionally among the outflows. Causality, or attribution of responsibility, directly results from this assumption that allows one to trace the flows back or forward. Robustness, i.e., little volatility with respect to input data or the absence of arbitrary decisions such as the choice of a slack bus which critically influences the results in other more sophisticated methods, is a very desirable characteristic. This is even more so when the application of the method has significant economic implications for the network users. The method of average participations is obviously not free from assumptions, —such as the rule of proportional allocation of flows at each node that is not fully supported by engineering principles (and it cannot be, as power does not really flow in the networks as a fluid in a pipeline)—, but this rule is of a physically intuitive nature, very much associated to the robustness qualities of the method, and it basically guarantees the reasonability of its results, which cannot be easily challenged³⁰.

The algorithm of average participations has been used, with minor variations, in real systems such as New Zealand (since the late eighties), Poland or South Africa, as well as in specific transmission pricing studies in at least Chile, Central America, Romania and Spain. It can be programmed easily and it has been studied thoroughly in the technical literature³¹. It is not free from objections, as it will be discussed below, but it appears to be a reasonable procedure whose level of sophistication is well adapted to the problem under consideration.

Description

The method requires as its basic input data a complete snapshot of the network power flows corresponding to the specific system conditions of interest. The algorithm is based on the assumption that electricity flows can be traced —or the responsibilities for causing them can be assigned— by supposing that, at any network node, the inflows are distributed proportionally between the outflows. Under these assumptions, the method *traces* the flow of electricity from individual sources to individual sinks; i.e., the model identifies, for each generator injecting power into the network, physical paths starting at the generator that extend into

³⁰ It can be easily shown that the proportionality rule of branching is precisely the average of how all possible bilateral transactions in the considered scenario could branch, -following Kirchoff's laws-.

³¹ See, for instance, [Bialek, 1996], [Kirschen et al., 1993] or [Rubio et al., 2000].

the grid until they reach certain loads where they end. Symmetrically, the paths from loads to generators can also be found, yielding exactly the same results of allocation of responsibility of flows to generators and loads. Then, the cost of each line is allocated to the different users according to how much the flows starting at a certain agent have circulated along the corresponding line.

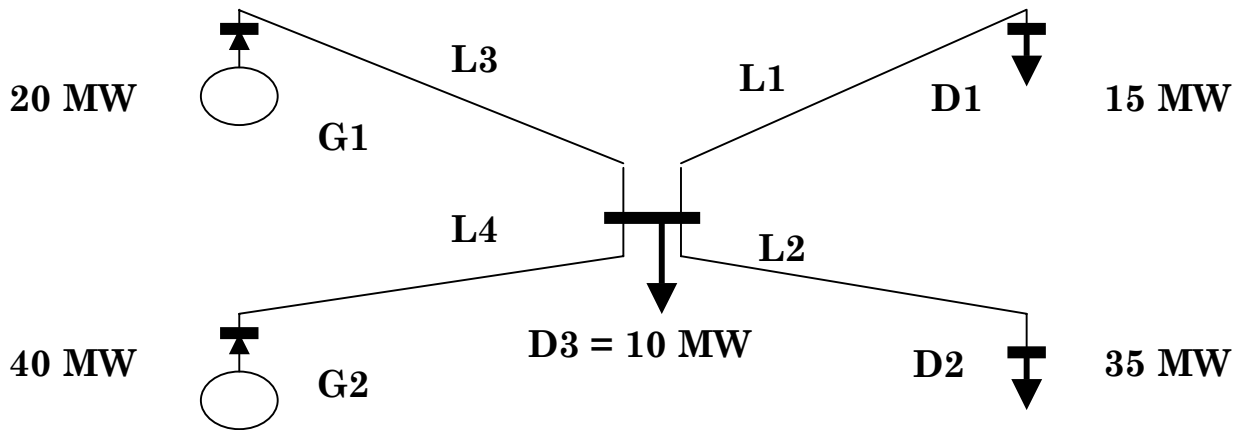

Figure 2: Proportionality principle in average participations

This is how the method works: for every individual generator i , a number of physical paths are constructed, starting at the node where the producer injects the power into the grid, following through the lines as the power spills over the network, and finally reaching several of the loads in the system. An analogous calculation is also performed for the demands, tracing upstream the energy consumed by a certain user, from the demand bus until some generators are reached. One such physical path (with as many branches as needed) is constructed for every producer, and for every demand. In order to create these paths, a basic criteria is adopted: in each node of the network, the inflows are allocated proportionally to the outflows. This makes the method easier to implement. A simple example is shown in Figure 2.

According to the proportional distribution rule, generator G1 would contribute $15 \times 20 / (20 + 40)$ MW to the flow in line 1, $35 \times 20 / (20 + 40)$ MW to the flow in line 2, as well as the total of 20 MW in line 3 and nothing in line 4. Similarly, demand D2 would contribute $20 \times 35 / (10 + 15 + 35)$ to the flow in line 3, $40 \times 35 / (10 + 15 + 35)$ to the flow in line 4, all the 35 MW in line 2 and nothing in line 1. The demand D3 of 10 MW has a contribution of $20 \times 10 / (10 + 15 + 35)$ to the flow in line 3, $40 \times 10 / (10 + 15 + 35)$ to the flow in line 4 and no contribution to the flows in lines 1 and 2.

The participation of agent i in line j is obtained as the part of the flows starting at agent i that pass through line j . The method implicitly results in a 50/50 global allocation of costs to generators and demands. However, if desired, an *ad hoc* weighting factor could be used to modify this percentage. In the marginal participations method, as we shall see later, this decision is linked to the choice of the slack node.

A more detailed explanation of a more complex example can be found in Annex 6.

Dispersion of the participations

As we have just seen, the average participations (AP) method calculates the participations of an agent located at a node i by tracking the utilization of the network by the input or withdrawal made by agent i until it reaches several ending nodes that result from the rules that conform the algorithm. These final nodes are different for each node i and they are implicitly defined by the procedure. As in the marginal participation (MP) method, global energy balance in the network requires that some nodes must absorb the injection or withdrawal of electricity at node i . But in average participations the end nodes are not defined by the user as in the MP method; instead, they are a result of the model itself. The rules that are employed to obtain these nodes are completely pre-defined by the AP model.

In the AP method, unless an area is transited by a prevalent flow pattern with far away sources and sinks, the network flows tend to originate and end in nearby nodes. This is a very interesting feature, since it avoids the dispersion problem of utilization factors of the MP method, which is clearly outperformed by the AP in this regard.

It is also clear, from what has been described about the AP method, that it totally ignores political borders and any relationship, —whether commercial, nationality, being owned by the same company, being operated by the same TSO or ownership of the wires—, between generators and loads, other than the relationship that is established by the pattern of existing physical flows.

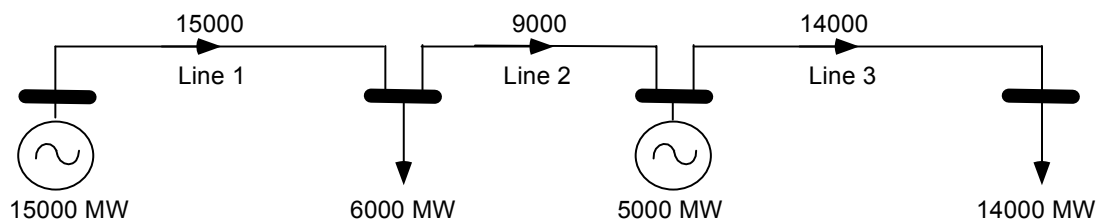

Figure 3: Political borders are ignored.

The results of allocation of responsibility of use that are obtained with the method of average participations are, in general very reasonable. However, in some cases the method may give results that, at first sight, are unexpected and appear to be contrary to intuition. Let us consider for instance the 4-node network model in

Figure 3, where there are two demand nodes and two generator nodes. It is immediate to obtain from application of the method that, assuming equal global weight in network use responsibility to generation and demand, the demand of 6,000 MW uses 20% of line 1 and the generation of 5,000 MW uses 17.8% of line 3. These results appear to be reasonable since, *given the left-to-right direction of the physical flow*, a demand such as the 6,000 MW that is located downstream of the main generator of 15,000 MW must be assigned a fraction of the use of line 1. The same reasoning could be applied to the generator of 5,000 MW, since it uses line 3 to export its output. All this appears to be completely logical so far.

However, there might be reasons that advise the adoption of a special treatment for balanced subgroups of generators and loads under specific circumstances. This may be the case of the allocation of network costs in a multinational market where, because of historical reasons in network utilization or because of the negative economic impact that the application of the AP method could have on them, individual countries might argue that their national networks are primarily employed to allow their national demand to be met by their national generation, and that only the mismatches between their national generation and demand will result in export or import flows that will use other countries' networks³².

Consider now for instance Figure 4, where the demand, the generation and the network flows are identical to the case in

Figure 3, but where political borders have been drawn. It happens that the demand of 6,000 MW, the generation of 5,000 MW and line 2 are located within the same country A. One can reasonably consider that the load in the moderately importing country A is primarily served by the generation within the same country, —in this example the 5,000 MW generator—, although 1,000 MW of imports from external generation are also needed. In the same way, a fraction of the generation of an exporting country would end up in loads that are situated outside the country.

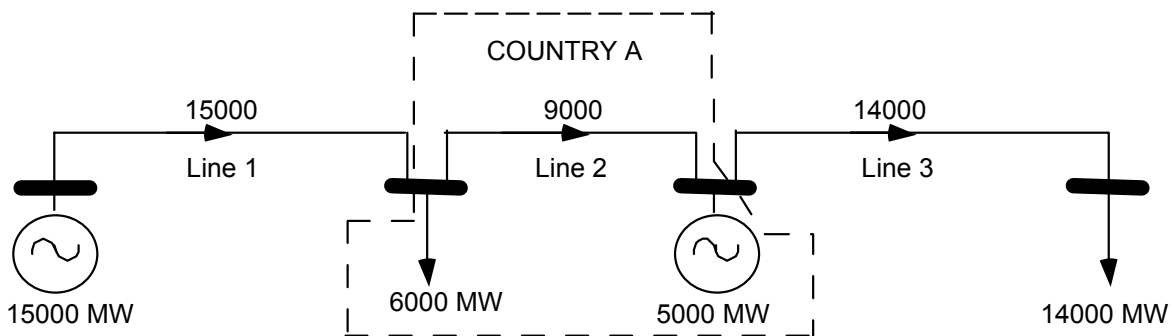

Figure 4: Political borders are considered.

With the example in Figure 4 one could argue that the load of 6,000 MW and the generator of 5,000 MW within country A only use its internal line 2 plus the external network (lines 1 and 3) but only with the 1,000 MW of imbalance. Therefore the high percentages of external network use of the load of 6,000 MW and the generation of 5,000 MW in the example in

Figure 3 look now like an unfair allocation of costs.

We are facing here the same dilemma as national regulators when they have to establish the transmission tariffs for a large industrial demand of 1,000 MW that is

³² Other countries that are poorly interconnected might argue exactly in the opposite way: they could consider that the agents in heavily transited countries are fortunate enough, since they have full access to the competitive market forces of the IEM. The cost allocation algorithms that are examined in this report nothing can say about the quantification of the benefits of being strongly interconnected within the EU Internal Electricity Market.

supplied by its own generator, located only 5 kilometers away in the transmission grid. If we ignore the commercial relationship between both, the standard transmission tariffs (perhaps not very accurately determined, as it is usually the case) would be applied separately to each one of them. However, the company that owns both the industrial demand and the generator would claim that they have to pay only the 5 kilometers of the line joining them plus the occasional use of the complete grid when either the generator or the load are not available.

If we adopt the viewpoint of country *A* as a joint entity using the network and not as the sum of its components (generation and demand) taken in isolation, then we cannot make use of the physical flows in the lines to determine the utilization of the network that can be attributed to the 6,000 MW demand and the 5,000 MW generator. In section 3.1.3 a possible alternative approach is presented.

Note that the two perspectives, —a) no political borders, b) political borders—, make sense when each one of them is contemplated individually from its own assumptions. However, each one results in a different set of use allocation factors. And the “single system paradigm” clearly requires that, sooner or later, any claims that are based on political borders should disappear.

3.1.1.1 The method proposed by CREG/SFOE³³

This section tries to show that the method proposed by CREG/SFOE at the 8th Florence meeting in February 2002 is fully equivalent to the standard method of average participations that has been described in the previous section of this document. Both methods can be applied to fully detailed real networks or to simplified network representations. Since the comparison between methods when applied to simplified models may become confused by the specific simplifications that are adopted (such as the definition of transit or allocation key to transit and internal use), here the comparison between both methods will be established in the case that both are applied to a real network model, where every individual transmission line is represented.

The CREG/SFOE method starts by considering each individual line (or any other element with cost, such as a transformer) one by one and by determining its cost per unit of physical flow (just by dividing the cost of the element in € by the actual physical flow in the element in MW). Then the physical flow in the element is traced both upstream (towards the generators, in order to determine the origin or source of this flow) and downstream (towards the loads, in order to determine the sinks of this flow). When tracing the flow, it is necessary to determine how to split the flow at the interconnecting nodes. Both algorithms use the same heuristic proportionality branching rule.

³³ This note represents the personal understanding of the method by the authors of this document, after reading the documentation that has been distributed in at the 8th Florence Forum, as well as some additional material provided by Prof. Glavitsch. The description that is provided of the method is slightly different (but equivalent, in the opinion of the authors) from the one that is used in Prof. Glavitsch’s transparencies, so that the common features of both methods are emphasized.

The key point is to realize (this is easily proved) that the final results that are obtained in the allocation of flow responsibilities to the generators and consumers located in the different nodes are exactly the same with independence of the specific mode of application of the algorithm of average participations: a) start from generators and trace the flows downstream towards the loads; b) start from consumers and trace the flows upstream towards the generators; c) start from the physical flow at each line (or other network element) and trace the flow both upstream towards the generators and then downstream towards the loads. The aggregation of the results for all nodes and lines yields the same final network use allocation coefficients in the three cases. Therefore the average participations method and the CREG/SFOE method should result in exactly the same coefficients of network use for each one of the agents of the system.

One minor difference between both methods is caused by the format of presentation. While the standard average participations method only considers flows and utilization factors first, —before applying the utilization factors to determine economic compensations—, the CREG/SFOE method associates a cost to each flow emerging from a network element (just by multiplying by the per unit factor described before) and therefore the results are directly presented as economic flows towards the agents that are responsible for them. However, the final numerical results are identical. If thresholds on external use factors are to be used, it is probably more “politically correct” to establish the thresholds in terms of network usage (avoiding therefore the use of money at this time) and only afterwards determine the economic consequences.

Another potential difference has to do with some options that may be adopted when using any of the two methods. In the standard average participations method the flows are traced until they die in a generator (if the flows are traced upstream) or in a load (if the flows are traced downstream). In the CREG/SFOE method, such it appears to have been implemented from the available documentation³⁴, the economic flows die at the moment when they cross a political border, therefore implying that economic compensations will only take place between neighboring countries. Both methods could have adopted this particular option, although it seems that the choice made by the standard average participations method is preferable. The reason is simply that in order to trace the origin of a given flow one may need to cross one or more borders.

The CREG/SFOE method offers an interesting idea when applied to the simplified network representation (one node per country) of the SAP method in the next section. Since the internal functioning of the network within the country or TSO is ignored in the simplified model version, a coefficient “alpha” is introduced, so that the user of the algorithm may input a weighing factor expressing how much the “transit” is actually using the internal network. If the lack of data makes one to have to recur, even if temporarily, to the simplified model, this idea may be of interest.

³⁴ This has been disproved by people knowledgeable about the CREG/SFOE method in personal conversations with the first author of this document.

3.1.2 Algorithm 2: Simplified average participations (SAP)

This method is only of interest if the available data do not support the full fledged algorithm of average participations. Note that not only one snapshot or scenario is able to faithfully represent the network utilization during any given year. A large number of snapshots or scenarios will be needed, with 8,760 hourly scenarios being the ideal objective.

Therefore, an option would be to accept a simplified representation of the IEM network transitorily, while the procedures to gather enough data are established and the data are collected to apply to full AP method. Then AP could be applied to a simplified network model of the IEM, where each country is represented by a single node. Under a methodological perspective, the procedure to be applied is exactly the same AP method. The only, —and not minor—, difference is that now the AP algorithm would not be applied to the existing real network model, but to a very simplified model of the IEM network, where only one node for each one of the different countries, and the interconnection lines between them, would be included. Note that the lines that join the nodes now represent the borders between countries and the flows in these lines the aggregated flows between neighboring countries at each one of the borders.

In order to apply the average participations method with equivalent aggregate nodes to a given operating condition, the only information that is needed is the snapshot of the corresponding aggregated import and export flows at each border between neighboring countries or TSOs if it is only considered the internal imbalance for each country. In addition, in order to somehow evaluate the ratio of external use of the network of a country k by other countries, some other information may be required, such as the total internal demand in country k at the considered time (if losses are not considered, it is straightforward to obtain all the information required to apply the algorithm from the import and export flows aggregated at border level and the total internal demand or generation).

Once the average participation method has been applied to this simplified model of the system, the responsibility of the different countries in the flows on each one of the inter-connectors between systems is known. Next, in order to determine how much each country k is using of the grid of another one j , it must be compared the amount of flow ‘using’ the grid of country j that country k is responsible for to the total amount of flow through the grid of country j . The amount of flow through the grid of one country j that another country k is responsible for is computed as the maximum between the aggregate value of import flows to country j caused by country k on one side and exports from country j that have been allocated to country k on the other.

The major drawback of this simplified implementation of the method of average participations is that it fully ignores the behavior of the network flows inside each one of the countries or TSOs³⁵. In order to overcome this shortcoming, albeit in a

³⁵ But at least it considers the topology of the countries or TSOs relative to one another, which is something that is ignored in the current provisional mechanism of inter-TSO payments.

very crude form, the CREG/SFOE documentation offers an interesting idea: A coefficient “alpha” is introduced per country or TSO, which is a weighing factor that the user of the algorithm may input to the model in order to modify the standard ratio of external usage utilization for each country: $\text{transit} / (\text{transit} + \text{internal demand})$ so that it becomes $\alpha \times \text{transit} / (\text{transit} + \text{internal demand})$, where a different alpha factor is used for each country. In the case of the standard AP method this coefficient alpha would be used to express how much each MW, either generated or consumed by an external agent, is using the grid of the country on average in comparison to the average use by a MW both generated and consumed within the country. Obviously the user of the algorithm must have some insider knowledge on the pattern of network flows within each country in order to be able to make this assessment.

The method of simplified average participations (SAP) entirely coincides with the version of the CREG/SFOE method that was presented at the 8th Florence Forum. The SAP method had been already discussed at the joint working groups of ETSO and the CEER that were organized by DG TREN after the 5th Florence meeting.

The major advantage of the SAP method is that it only requires a very reduced set of data. Since it is expected that the required data for this simplified network will be available for the 8,760 hours of any given year, this method will not require the use of a reduced set of scenarios. Note that the application of the SAP method could be a reasonable transitory solution since: a) 'the accuracy in the data would be at least equal to that of the current provisional approach, since it is based in a similar set of data (import and export flows for each country and every hour, unbundled by borders); b) the methodology could correct most of the conceptual shortcomings of the current transitory mechanism.

The major disadvantage of the method is the lack of accuracy in the representation of the network. As a consequence, it totally ignores the behavior of the flows in the network that is internal to each country. A significant loss of accuracy must be therefore expected. Therefore, if this approach were adopted transitorily because of lack of better data, one should try to replace it as soon as possible.

3.1.3 Algorithm 3: Modified average participations (MAP)

Background

It has been already discussed in section 3.1.1 that, since political borders are totally ignored in the algorithm of average participations (AP), it may occasionally happen that the generation and demand of comparatively small, well balanced and heavily transited countries appear to have sinks and sources, respectively, that are located externally to these countries, which therefore appear to be heavily using other countries' networks. This makes the charges of these countries in the inter-TSO payment scheme to be larger than somebody could expect. As indicated in section 3.1.1, where this effect was discussed first, this apparent difficulty vanishes when the allocation of network costs is only based on the actual physical flows and ignores political borders.

In order to provide a solution to this hypothetical problem, a variant of the AP method has been developed: the modified average participations method, MAP. The

MAP method may be used in case that it is desired to allocate the network costs so that the internal generation of a country is assumed to use primarily the national network when meeting the national demand, while only the imbalance between the internal generation and demand will be assumed to be primarily involved in external network use.

Description

The implementation of the MAP method is very simple and it makes use of the same algorithm of average participations (AP). For a given country j , all generation and demand is collapsed into a single node N with the net balance of the country. Therefore at N there will be a single generator or a single load, depending whether the country is a net exporter or importer, respectively, at the time of the snapshot being considered. Then the node N is connected directly to each one of the border nodes of country j , where this country imports or exports electricity. The flows at the interconnection lines remain at their actual values and nothing is changed in the networks or the flows outside country j .

Now, when computing the external effect of country j on the remaining countries, the usual procedure of the standard method of average participations will be followed. If country j is a net exporter only the exporting flows from country j will be traced downstream. Note that only the part of the export flows that is in excess of the import ones will be considered when computing the external use that country j is making of other networks. Conversely, if country j is a net importer only the importing flows will be traced upstream, being the process completely analogous to the one just explained for exporting countries. Since only the net export or import of country j is considered to use the external grid, the external network use by country j will be significantly reduced in transited countries, while purely exporting or importing countries will be unaffected. Thus, the “perturbing” effect that was mentioned before entirely disappears. The only external network utilization by a country j will be due to the imbalance between its internal load and generation.

Once the charges that each country j has to pay to all other countries are known, it is straightforward to compute the total compensation that is due to each country and the net balance of charges and compensation for any given country.

The MAP method makes extensive use of political borders, which in principle should not influence transmission charges in a multinational market according to the “single system paradigm”. Therefore, it does not respect this paradigm and it is discriminatory, since it applies a specific treatment to the agents depending on the internal balance of generation and load within their countries. Note, for instance, that two identical generators with exactly the same outputs and located very close in the network, but at different sides of a border, may receive a quite different treatment under the MAP method. This method might be adequate for a transitory period in the implementation of multinational markets, while the regulatory procedures gradually adapt to a more open model where political borders may be ignored for network tariffication purposes.

3.1.4 Algorithm 4: Marginal participations (MP)

Background

The method of marginal participations³⁶ (often named *areas of influence*, after Chile) has been used in Chile or Argentina since these systems were restructured, and also in other Latin American countries. This procedure calculates how much would the flow in line j increase if the generation (or load) in node i increased by 1 MW, i.e., the method obtains the per unit measure of marginal participation on line j for any agent located at node i . This calculation is performed for every node, for all the lines in the grid and for a representative number of load flow scenarios. Then, the cost of each line is allocated to the different users according to their participations in the line. Several variations on this basic approach are possible.

The problem with this method is that, due to Kirchhoff's laws, any 1 MW increase in generation (or load) at node i has to be compensated by a corresponding 1 MW (ignoring losses) increase in load (or generation) at some other node or nodes. Thus, the calculation of how much an injection at a certain bus affects the flows in the network depends on the decision of which is the node that responds, and the basic answer that is demanded from the method is heavily conditioned by an assumption that it needs as an input. Different choices are possible for this "slack bus" (the responding node or nodes in power systems terminology): near the major load center (as in Argentina or Chile), a distributed virtual node so that all the demand responds pro rata, the marginal generator in the market or in the centralized economic dispatch, etc., but they may lead to widely different results. The selection of the slack bus becomes an important problem; the choice has much practical importance, but there is no clear criteria to decide.

Description

Any usage-based methodology tries to identify how much of the power that flows through each one of the lines in the system is due to the existence of a certain network user, in order to charge it according to the adopted measure of utilization. To do so, the MP method analyzes how the flows in the grid are modified when minor changes are introduced in the production (or consumption) of agent i , and it assumes that the relationship of the flow through line j with the behavior of agent i can be considered to be linear. For each one of the considered scenarios, the procedure can be described as follows:

1. Marginal participation sensitivities $A_{i,j}$ are obtained that represent how much the flow through line j increases when the injection in bus i is increased by 1 MW.
2. Total participations for each agent are calculated as the product of its net injection by its marginal participation. Net injection is positive for generators and negative for demands. So the total participation of a generic agent i in line j is $A_{i,j} \cdot (g_i - d_i)$.

³⁶ See [Utilities Policy, 1997], [Vázquez et al, 2002] or [Rubio et al., 2000], for instance.

3. The cost of each line is allocated pro rata to the different agents according to their total participation in the corresponding line.

The linearity assumption does not introduce significant errors. The critical task is the computation of the sensitivity factors $A_{i,j}$.

It is a fundamental technical characteristic of power systems that generation and demand must be always balanced. Therefore, if the generation at node i is incremented in 1 MW so that one can compute its marginal sensitivities, then some other nodes in the grid must increment their demand or reduce their generation in order to keep the system in balance. Hence, what the sensitivity $A_{i,j}$ is really expressing is how much the flow through line j increases when the generation at bus i is increased in 1 MW and the demand at the slack bus is increased in 1 MW (ignoring losses). In other words, $A_{i,j}$ is telling us how much of a hypothetical transaction starting at node i and ending at the slack bus would go through line j .

The DC load flow model allows one to define any node or combination of nodes as the slack bus, with some easy numerical manipulation, but one must be aware that choosing the nodes that respond influences heavily the final results, so it is a decision not to be made arbitrarily. Note also that the method, as it is presently applied, always uses the same slack bus to respond to any increment in generation or load in the system. A common choice for the slack node is a major load center. Chile and other Latin-American countries use some network node that is as close as possible to the largest city, where a significant amount of the load concentrates. This makes the network users that are close to the slack bus (most of them consumers) pay reduced network charges, while distant market participants (most of them generators) tend to pay high transmission charges.

Another alternative is the use of a distributed virtual node, so all the generators (or all the loads, or both) respond jointly to any unbalance, in proportion to their level of production (or consumption, in the case of loads). When calculating the marginal participations of an agent located at node i , this alternative implies considering a transaction that starts at i and reaches practically every node in the system, so the method generally results in participations for agent i in almost every line in the grid. Of course, participations are higher in the lines that are closer to the considered agent, but the area where they are not negligible is relatively wide. In fact, depending on the generation pattern, important participations may appear in lines that are very distant to node i .

Implications of the selection of the responding node

The choice of the slack node modifies the allocation of network charges between supply and demand. Annex 5 examines in detail the impact that a change of slack bus has on the transmission charge for any given network user. The conclusion is that, for every network user, a change in the slack node results in an additional term K in the per-MW transmission charge. This additional term is the same for all of the network users.

The former property is only true if negative participations are fully taken into account. Some implementations of the marginal participations method have chosen

to consider only positive contributions, ignoring the negative ones; in that case the property described above would not hold.

The fixed term that appears modifying the unitary transmission price after a change in the slack is affected by the net injection in each bus so, whenever it is additive for any generator, it is additive for all of the generators in the system and subtractive for all of the demands, and vice versa. A change in the slack bus determines the global percentage of the network costs to be paid by all the producers and all the consumers. In other words, if for some reason the regulator has made an a priori decision regarding the global split of the total network costs into generators and consumers, then this amounts to a selection of the slack bus. Both decisions are equivalent. This is a very attractive property of the marginal participations method, and it provides some meaning to the seemingly arbitrary decision of choosing the slack node. Note, however, that the split of charges to generators and consumers according to any pre-established ratio can be also accomplished easily with the method of average participations, as it was shown in section 3.1.1.

Another interesting feature of the MP method is that the differences in network tariffs between nodes are not affected by a change in the slack node. The decision of a generator about whether to install at one network node or another depends, — obviously among other reasons—, on the difference between the transmission tariffs that it will be charged at the two locations. Since the difference between tariffs does not depend on the choice of slack bus, the location signal is not influenced by this decision. In principle, this makes MP an attractive method for the purpose of providing locational signals.

When the wholesale market is perfectly competitive, it can be easily shown that any payment or tax charged to all producers, —such as a uniform adder to the transmission tariff—, would be passed on to the consumers via market prices, sooner or later. The implication is that, regardless of the choice on the split of transmission charges between generators and consumers or, equivalently, regardless of the choice of slack bus, the final result would be the same. Then the choice of slack node would be immaterial. Note that the situation is different when the markets are not perfectly competitive, as it is the case in most existing electricity systems. Then the decision about the split of the transmission costs between generators and consumers becomes more relevant and, consequently, also the choice of the slack node.

Dispersion of the participations

Despite the attractive mathematical properties of the charges that are derived from the MP algorithm, one has to make sure that these charges make engineering and economic sense in the first place. An alternative way of analyzing the impact of the choice of the slack node on the transmission tariffs is the examination of the participations of the different agents in all the network lines. If a distributed slack node is adopted, —i.e. all of the generators (or demands) respond pro rata jointly to any change—, it can be seen intuitively that each node participates in almost every line in the network. In the European case, for example, network users in Portugal would have non-negligible participations in systems as far as Poland, since part of the increments originated at the Portuguese nodes would be compensated by the

Polish nodes, although it seems clear that the actions of the agents in Portugal will have very scarce actual influence on the Polish network. This dispersion is a direct consequence of an intrinsic feature of the method of marginal participations: a single node or combination of nodes responds to the increments of all the generators and loads in the system. Then the dispersion in the participation factors is unavoidable. This is particularly troublesome in the case of a multinational market where a single slack node has to be defined for the entire system.

A very extreme and intuitive example would consist of two well-meshed areas linked by a very weak interconnection, as in Figure 5. If a fully distributed slack node is chosen, for a generator located in one of the two areas the method of marginal participations would yield participations in lines at both halves of the system. Then, any network user would have to pay a relevant part of the network in the neighboring area. This would happen even though the power flow through the interconnection might be close to zero. Intuitively it seems that this generator should basically pay transmission charges for the network in the area where it is located and the allocation obtained from the method appears to be incorrect.

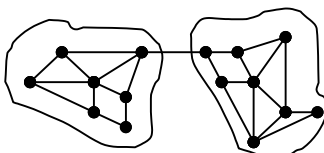

Figure 5: Two areas example

This is a relevant objection against the method of marginal participations. Note that in a regional market, the network users from any country that is far away from the slack node, —or if the slack node is a distributed one—, will have non zero and meaningless participations in a high number of distant lines. The same problem can be perceived when looking at the allocation of the transmission costs of that country between its generators and consumers. While the consumers (or generators) in that area will be paying a high transmission charge that represents a large and positive percentage of the costs of their national grid, the producers (or consumers) will be paying an also large but negative percentage, i.e., they will be receiving a net income. Although, theoretically, this is a possible way of allocating the totality (100%) of the transmission costs of the country, —as 300% to consumers and -200% to generators, for instance—, this allocation is hard to accept in practice.

A stronger objection to the MP method results from the fact that it ignores the capacity of the interconnections and also whether they are congested or not, since the method is based on marginal variations and not on average flows. Imagine that the slack node is located at Bonn. In order to compute the participation in the use of the European network of a consumer in Portugal, we must increase by 1 MW the load of this consumer, let the slack generator at Bonn respond to the increment in load and then observe the modifications in the network flows. The result of this analysis does not depend on the volume of the interconnection capacity between France and Spain (that the Portuguese consumer is using in the example) or on the status of this interconnection, -whether congested or not-. But the effective use that Portuguese consumers make of the French or the Danish networks critically

depends on the capacity of this interconnection, the direction of the flows in it and the congested status of the lines. For instance, with the MP method a consumer in Portugal would pay basically the same fraction of the Danish network regardless of the capacity of the interconnection between France and the Iberian peninsula. This result is also difficult to accept.

Balanced subgroups

Another interesting property of the MP method is related to subsets of network users with generation and demand that are completely balanced (we shall refer to them as balanced subgroups). The net participations that are assigned by the MP method to a balanced group of users, —by adding up the participations of all the individuals forming the group—, are independent from the choice of slack node. In effect, by using the superposition principle, it can be seen that the flows originated from a 1 MW increment in the production of generator *A* and a 1 MW increment in the demand at the slack node, plus the flows resulting from a 1 MW increment in the generation of the slack node and a 1 MW increment in the demand at node *B* are equal to the flows resulting from a 1 MW transit between *A* and *B*, and they are the same for whatever slack node that might have been chosen.

The total network usage measure calculated by the marginal participations method for a balanced group of agents coincides —assuming that linearity approximately holds— with the sum of the flows that are caused by each one of these agents individually. For instance, a subgroup consisting of a generator and a demand of the same size and located at the same node will be assigned by the marginal method no network use. Countries that are well balanced in generation and demand will have a weak use of the external network. Whether this is a desirable feature or not is still an open issue, but the potential objection that was discussed in section 3.1.1 regarding the AP method would not apply to the MP method.

Family 2: Algorithms that are based on the impact of transits on each considered country

The concept of transit is an intuitive one and it is apparently a simple concept to use. It is normally defined as the part of the flows on the grid of a country that has nothing to do with the power injected or produced by the country. In other words, the flows that comprise the transit on the grid of a country are those that have not been injected to or withdrawn from the agents inside this country.

It seems very reasonable to charge the agents responsible for the transit through a country *j* with the costs born by this country due to the existence of the transit. These costs would correspond to the fraction of the network of country *j* that is actually being used by the transit and the losses in that network that are incurred by the transit.

Several definitions of transit are possible, as it is not possible to translate the intuitive but imprecise definition of transit that has been given above into a clear mathematical expression. The difficulty stems from the fact, —which we have also encountered when dealing with the first family of methods that are based on electrical use—, that we do not have an indisputable method to ascertain which

flows at the border of a country go through it and which ones are associated to the internal agents.

ETSO has been systematically using a definition of transit that is very simple to compute and has intuitive meaning. Given a country j with multiple interconnections with other countries, resulting in as many import and export flows, the sum IMP_j of all import flows is computed first and then the sum EXP_j of all export flows. Then the transit is defined as

$$\text{Transit in country } j = \text{Minimum of } [IMP_j, EXP_j]$$

Therefore, it is assumed that any border flows that cannot be justified as a net export from or import to country j should be transit flows. Once the total value of the transit has been determined, it remains how to distribute it among the several interconnection lines. ETSO has proposed to distribute it in pro rata of the flows at the interconnections. This is more easily shown with an example.

Let us consider the case in Figure 6, where a country has four interconnection lines, two of them with incoming flows of 2000 MW and 1,000 MW and other two with outgoing flows of 800 MW and 700 MW. According to the definition that has been given above, the transit for this country is the minimum value of 3,000 MW and 1500 MW, which is 1500 MW. Since we want to examine the effect of the transit within the considered country, we need to assign it to the two incoming lines. Then, the use of the pro rata rule will result in values for the transit of 1,000 MW, 500 MW, 800 MW and 700 MW for the lines with actual flows of 2000 MW, 1,000 MW, 800 MW and 700 MW, respectively.

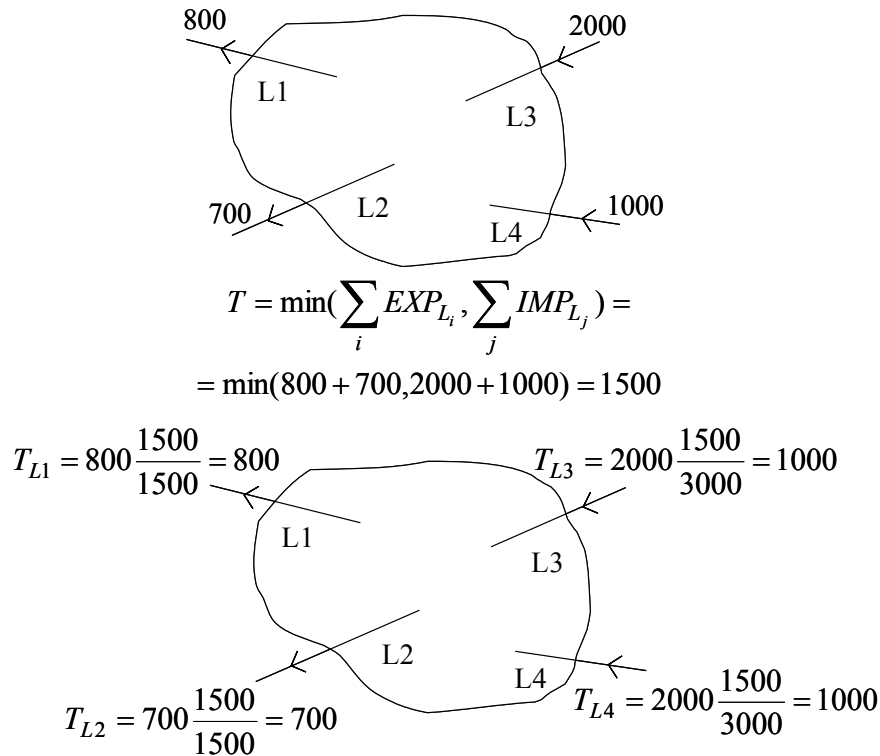

Figure 6: Definition of the flow pattern of the transit at the borders

The definition of transit given above obviously ignores the pattern of flows inside country j .

Figure 7 shows how this definition would result in the same value for the transit in a country under two very different circumstances A and B. Note that in case B there is no electric interconnection between the right and left parts of the country. It is difficult to accept that there is a transit in case B.

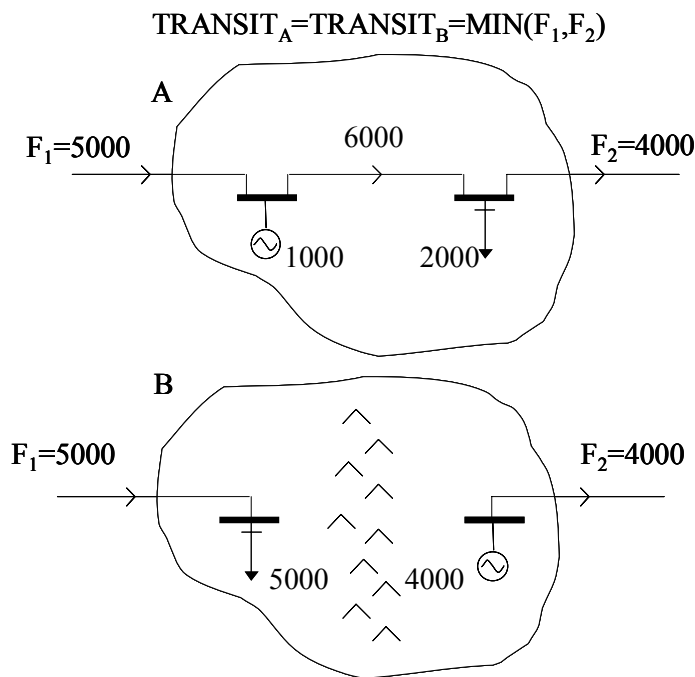

Figure 7: Transit according to ETSO for two different network topologies.

The ambiguity in the definition of the concept of transit is translated into two other practical problems: a) how to specify the flow pattern of the transit when there are more than two interconnection lines in the considered country (we have just commented the ad hoc pro rata rule of ETSO) and b) how to assign the responsibility for the transit. One additional difficulty is the precise definition of how to quantify the electrical use of a network by a given transit.

The dependence of the economic implications of transits on the definition of political borders is exemplified in the case shown in Figure 8. According to ETSO's definition of transit, the transit in country A is 3000 MW and it is therefore entitled to receive an economic compensation with the WWT method. However, by adding a new political border, the transits in the resulting countries A1 and A2 are zero and therefore they should not receive any compensation.

Despite these difficulties, the concept of transit has found wide acceptance among power system practitioners and it has been frequently used. Two algorithms that are based on transit are presented next. The first one, —the “with and without transit” approach, WWT—, has been presented by ETSO in the Florence Forum. The second one, —the average participations applied to transits method, APT—, is a new algorithm that uses the underlying technique of the AP to offer an alternative to some of the difficulties that are encountered by the first algorithm.

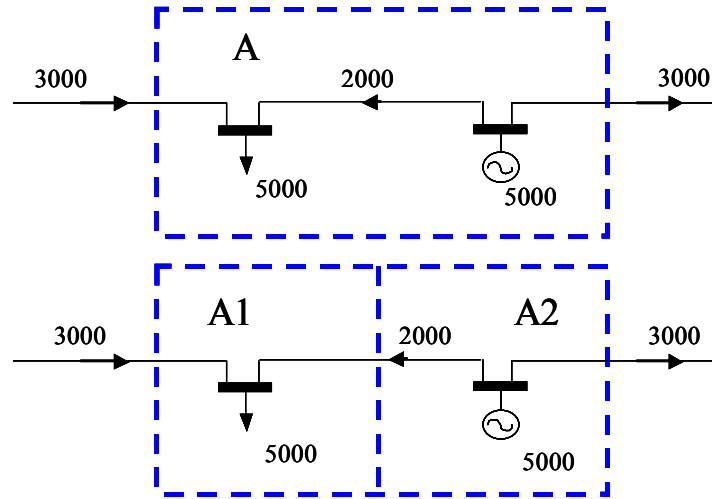

Figure 8: The influence of political borders on transits

3.1.5 Algorithm 5: With and without transit (WWT)

The most direct application of the concept of transit to the determination of the inter-TSO payments is the “with and without transit” algorithm. It simply amounts to establishing a comparison between the network flows in the considered country in the reference situation and in a fictitious one where the transit has been removed.

If the definition of transit and its allocation to the different lines that is provided by ETSO is accepted, then the fictitious “without transit” situation is completely identified. A load flow has to be run to determine the flows in the network of the considered country for this new system condition. Note that care and engineering judgement might be needed in the evaluation of the fictitious “without transit” situation, since the pro rata allocation of flows might result into bizarre local flows that have little to do with the physical reality of the actual power system. Note also that removal of the transit may result in an augmentation of the power flows and losses in the considered country, since the effect of the transit on the internal network flows will critically depend on the “direction” of the transit: in one direction the flows and the losses will tend to increase, while they should tend to decrease if the direction is the opposite. This is just an approximate statement, since flow reversals and other non linear effects may complicate the actual network behavior.

The next issue is the quantification of the impact of the transit in the use of the network for the considered country. One possibility is to determine the volume of flows that are caused by the transit itself, in the absence of any other prior network usage. Another possibility is to compare the flows in each line “with and without transit” and to consider only those that have increased because of the transit. Finally, the third one, which has been used to obtain the results that are presented in chapter 5, consists of computing a global measure of network usage, —the total

volume of MWxkm in the entire network—, and to compare this amount in the two “with and without transit” situations.

A serious inconvenient of the “with and without transit” algorithm is that does not provide any idea on how to allocate the charges that correspond to the compensation that has just been calculated for any considered country. ETSO has not provided yet an indication on how to address this issue, which is obviously critical for the computation of the inter-TSO payments.

In the implementation of the WWT method that has been adopted in the present report, it has been used a rule that has been borrowed from the method that NORDEL uses since January 2002 for the computation of inter-TSO payments that are exclusively based on losses. According to this rule, 50% of the compensation that is due to a country j is charged to all other countries as pro rata of their gross exports. The remaining 50% is charged to all countries different from j as pro rata of their net flows, i.e. the absolute value of the difference between exports and imports of each country. Note that this allocation scheme would not take into account the topology of the considered set of countries. This may be reasonable for a small subset of countries within the IEM, such as NORDEL, but it does not seem correct for the entire IEM. According to this rule Portugal would be assigned the same percentage share of the compensations of Spain and Finland.

3.1.6 Algorithm 6: Average participations applied to transits (APT)

The purpose of this method is to solve two of the major inconveniences of the WWT method, while preserving the same underlying philosophy of evaluation of the impact of transits: the need to define the fictitious “without transit” situation and the allocation of responsibilities for causing the transits.

The APT method starts from the same definition of transit as in the WWT method. Then, for any given country j , once the transit flow at each one of its interconnections has been determined, the algorithm consists of tracking these transit flows both upstream and downstream, in order to determine: a) how much the transit flows are using of the network of country j ; b) which is the origin of the transit flow, in order to allocate responsibilities.

This task is performed with the same technique as in the AP algorithm. Let us assume that country j has an interconnection with an actual incoming flow of 1,000 MW and that it has been determined that the transit flow in this line is 300 MW. The idea is to track the flow of 300 MW inside country j in order to determine how much it uses this network. But the 300 MW flow is also tracked upstream, outside country j , so that the responsibilities in causing this transit flow can be assigned.

It has to be acknowledged that the quantitative results of the WWT and the APT method may differ significantly. The reason is that WWT is an incremental method (when the transit flow is removed, flow reversals and other nonlinear effects may happen), whereas APT is based on average effects of the actual flow pattern.

Some of the criticisms that were raised against the WWT method still persist, — such as those derived from the ambiguous concept of transit—, but others have been removed.

3.2 Compensations and charges due to losses

The methods of allocation of losses that have been examined in this report are, for the most part, parallel methods to the ones that have been already presented for the allocation of the network infrastructure costs. However, some new algorithms have been introduced, which make use of marginal loss factors. It must be considered as a positive feature of the adopted long-term mechanism that there is consistency between the methods for allocation of losses and infrastructure costs. The methods for loss allocation could be also grouped into two major families:

Family 1: Based on the network utilization of individual agents and complete actual cross-border flows

- Algorithm 1: Average participations (**AP**).
It uses the results of the classical average participations algorithm.
- Algorithm 2: Modified average participations (**MAP**).
It uses the results of the modified average participations algorithm.
- Algorithm 3: Marginal loss factors applied to actual cross-border flows (**MP**).
Marginal loss factors are separately computed and then applied to the actual flows at the interconnections.

Family 2: Based on the impact of transit flows on each considered country

- Algorithm 4: With & without transit method (**WWT**).
It uses the results of the “with and without transit” algorithm.
- Algorithm 5: Average participations applied to transits (**APT**).
It uses the results of the algorithm of average participations applied to transits.
- Algorithm 6: Marginal loss factors applied to transits (**MPT**).
Marginal loss factors are separately computed and then applied to the transit flows at the interconnections.

In the following subsections this report describes and critically examines each one of these algorithms, indicating their strong and weak points. The numerical evaluations and comparisons are left for chapter 5.

3.2.1 Algorithm 1: Average participations (AP)

If the method of average participations is considered to be acceptable to determine the responsibilities of each agent in the actual flows in the network, the same allocation can be used to determine the share of the losses associated to the flows in the lines.

The computation is a byproduct of the results that are provided by the AP method. Once the AP method has allocated the flow of a line to a subset of the IEM network users, the same allocation factors can be employed to assign the losses in the line. In this way it is straightforward to allocate the losses in all the lines of a given country j to the network users in country j and to the network users in other countries. Compensation and charges are therefore determined.

3.2.2 Algorithm 2: Modified average participations (MAP)

The same comments in the previous section apply also here.

3.2.3 Algorithm 3: Marginal loss factors applied to border flows (MP)

This method has been discussed by the CEER Working Group on Cross-Border Tarification and included in the guidelines that were issued by CEER in February 2001. The method is based on the concept of EU-wide nodal energy pricing but the specific procedure to be used, does not require the application of nodal energy prices –neither at national nor EU-wide level–. It does not require the existence of an EU compensation fund, either. The presentation of the proposed methodology is done in two steps. First, a conceptual reference situation with full regional nodal pricing will be described, so that the fundamentals of the method are understood. Second, a valid approximation of the reference case to the present conditions of the EU Internal Electricity Market is proposed as the recommended procedure³⁷.

The reference case is characterized by: a) a well-defined regional transmission network, RTN; b) a centralized algorithm that computes nodal energy prices just for all the nodes of the RTN; c) regulatory diversity: while some countries use nodal pricing internally, other countries do not. Under these conditions, the following procedure correctly computes the allocation of losses among the different countries:

- i) Apply nodal energy prices at the nodes of the RTN (generators are paid and consumers pay nodal energy prices). This results in complete application of short-term economic energy signals to all users of the RTN (both to users directly connected to the RTN and, if the countries pass the signals internally, to all users). A net revenue NNR (nodal net revenue) is obtained, which should be used to reduce total charges of the RTN to its users. The problem now, in a regional context, is how to allocate these revenues to each country. Note that, if we ignore congestions, NNR only consists of charges related to losses. Any “compensations” between countries because of losses must be implicit in NNR.
- ii) Consider now the existing political borders. Now, in each country A apply nodal prices both at the internal nodes of the RTN and also at the new nodes that have been created at the borders between country A and the neighboring countries. The result is a nodal net revenue NNR_A for country A .

³⁷ These ideas were first presented in [Perán et al, 2001].

- iii) It is obvious to check that the sum of the NNR_A for all countries A in the region is the total NNR calculated before. The amount of the total revenues NNR of the RTN that corresponds to country A is precisely NNR_A .
- iv) Some entity collects NNR by applying nodal prices to all physical flows entering or exiting the RTN. This amount is distributed as NNR_A to every country.

The problem is that it cannot be assumed that every country will apply nodal prices internally. As we are only interested in the allocation of losses, we shall proceed to split the nodal prices into two components: a production component (common for all prices) and a loss factor, which is different at each node (network constraints are ignored here)³⁸. For each country the production component, when applied to each internal node and the flows at the borders, results in an economic deficit that is equal to the value of its internal losses when valued at the production component. On the other hand, the application of the loss factors for each country, —both at the internal nodes and the borders—, results in revenues for the country approximately equal to double of the economic value of losses. Therefore, there is a net surplus —after recovering the cost of losses— approximately equal to the economic value of losses, which can be used to pay for a part of the network costs. More specifically, the revenues R_A of system A because of losses are:

$$R_A = \sum_k PN_{INTk} (D_{INTk} - G_{INTk}) + \sum_k PN_{BORK} (EXP_{BORK} - IMP_{BORK})$$

where PN_{INTk} is the nodal price at any internal node k of system A , PN_{BORK} is the nodal price at any node k where the regional transmission network crosses any border of system A , D_{INTk} and G_{INTk} are the withdrawals or injections of power at the internal nodes of system A , and EXP_{BORK} and IMP_{BORK} are the export and import physical flows measured at the borders of system A .

If the nodal prices are decomposed into a single market price and node-specific loss factors LF , then the system experiences a net economic deficit equal to the total volume of transmission losses in the system times the market price. On the other hand, application of the loss factors results in a net revenue:

$$\sum_k LF_{INTk} (D_{INTk} - G_{INTk}) + \sum_k LF_{BORK} (EXP_{BORK} - IMP_{BORK})$$

which is approximately equal to twice the total volume of transmission losses in the system times the market price. The second term in the expression above is the inter-TSO loss compensation we were looking for. In effect, it accounts for all the contribution from neighboring countries to the losses in system A and it can be easily expressed in terms of bilateral transactions with the neighboring systems to

³⁸ The split cannot be defined in a unique way. It depends on the choice of the “slack node” that is necessary to make when computing the loss factors, see [Rivier et al., 1993].

system A . As with the network cost allocation algorithm, the computation of credible inter-TSO compensations and charges requires to apply the same algorithm repeatedly for a representative number of system conditions for the time period for which the cross-border tariffication analysis is intended.

The selection of the slack node is also a problem here, since loss factors (which inevitably depend on the choice of slack, are used instead of the complete nodal prices, and the final results happen to depend significantly from the chosen slack. This could be a sufficient reason to discard this method.

One interesting property of the marginal loss factors, as defined above, is that the net revenue happens to be totally independent of the choice of the slack node whenever the aggregated import flows equal the aggregated export flows, i.e., when the country has no net import or export flow; in other words, when it is only “transited” or when the procedure is applied only to the “transit” component (in any way that it is decided to define it) of the import and export flows. This property is exploited below in algorithm 6.

3.2.4 Algorithm 4: With and without transits (WWT)

This method is currently used by NORDEL, for this same purpose of computing inter-TSO payments for losses among its member countries. The algorithm makes use of the results of the WWT method for allocation of network infrastructure costs.

The required computation is straightforward. Once the network flows in the considered country j have been determined for both the with and without transit situations, the only thing to do is to compare the value of the network losses in both cases. Note, as indicated when explaining the WWT method, that the presence of a transit may as well increase or decrease the losses in country j .

3.2.5 Algorithm 5: Average participations applied to transits (APT)

The desired result can be obtained as a byproduct of the APT method. In the same way that tracking the transit flows reveals the fraction of network utilization of these flows in the considered country j , the fraction of the losses that are attributable to the transit are equally obtained. The responsibility for the losses is assigned exactly as it was done in the APT algorithm for utilization of network infrastructure.

3.2.6 Algorithm 6: Marginal loss factors applied to transits (MPT)

When describing algorithm 3, it was explained that the result of the application of marginal loss factors to the cross-border flows of a purely transited country gives a result whose value does not depend on the slack bus that has been used in the computation of the marginal loss factors.

Therefore, this MPT method simply consists of determining the transit flows, exactly in the same way as in the algorithms 4 and 5, and then apply to them the

marginal loss factors as explained in algorithm 3. The charges are allocated to the corresponding neighboring country.

4 Data requirements

The algorithms for the determination of compensations and allocation of network costs and losses that are considered as possible alternatives for the long-term mechanism for inter-TSO payments have been described in Chapter 3. Whenever possible, these algorithms make use of “real flow network models”, i.e., models that include the actual topology of the IEM transmission network and the interconnections with perimeter countries. The data requirements that support a real flow network model for any given operating condition or scenario (i.e. the description of the flows in all the lines of the network at a given instant of time) consist of a set of network, demand and generation data for all the interconnected electrical systems in order to obtain meaningful results for the particular scenario.

Credible results for calculation of compensations and cost allocation require the application of any selected algorithm to a set of scenarios that can be considered to be representative enough of the range of operating conditions in the year for which the inter-TSO payments are to be computed.

The difficulty with this type of studies does not reside in running a large number of cases with the computer, since these are off-line studies and today’s computers can handle very large network models within reasonable computation times. The only practical problem is the availability of data. Detailed procedures to collect and to verify these data systematically have to be established. This is why the definition of a satisfactory reduced set of scenarios becomes a critical task in the implementation of the long term approach.

What it is needed in the first place is the definition of the year for which the analysis of network costs is to be applied. Typically transmission tariffs in the different countries are determined at the end of a given year to be applied on the following year. When translated to the TSO-payment scheme, this would imply that the adopted set of scenarios should be able to represent the expected operating conditions of the IEM network for the next year satisfactorily. This enters uncertainty as an additional factor in the determination of the representative scenarios, whose number must increase in order to suitably cover all possible operating conditions (hydraulicity, demand and generation patterns, etc.).

The pragmatic solution that was adopted in the Florence Forum for the provisional mechanism is proposed that be also used here. It simply consists of computing the inter-TSO payments for year $N+1$ by using historical data of what happened in the European network during year N (actually, in order to leave some time for the computation of the tariffs, during the last three months of year $N-1$ and the first nine months of year N , for instance). This is very reasonable, since: i) the impact of inter-TSO payments on the final network access tariffs is not expected to be large, therefore the effect caused by any error that might be introduced because of this simplification will not cause any significant distortion; ii) there is no need to introduce any future adjustments because of the differences between the estimated conditions of operation for year $N+1$ and the actual operation conditions, once they are known, since all the computation are based on past historical data; the network

users end up paying the same total volume of charges over the years; iii) the data requirements are significantly reduced and the suitability of the reduced set of scenarios can be more easily verified.

In the next section 4.1 a specification of the data that are required to run the algorithm for just one scenario is provided. Then, section 4.2 presents the methodology that allows one to determine the number and characteristics of the scenarios that are required to provide a satisfactory and robust result for the inter-TSO payment mechanism.

4.1 Data requirements

The process of implementation of the long term mechanism for computation of inter-TSO payments basically consists of three phases, with each one of them having different data requirements:

A. *Selection and validation of the methodology for computation of compensations and allocation of charges.* This includes the qualitative and quantitative comparison of alternative algorithms. The quantitative analysis with real network models requires complete load flows for the entire IEM system for each one of the considered scenarios, plus some additional information in order to determine the network costs and to perform their allocation. For this validation it is not strictly necessary to have a model of the entire IEM network. It suffices to have a large fraction of it, which may also include the network of some of the perimeter countries.

This is the task that is addressed in the present report. Section 5.1 describes the data that has been used in the evaluation of the proposed algorithms and in the elaboration of this report.

B. *Definition of the reduced set of scenarios.* Ideally, this task would require to compare the results of network cost allocation that would be obtained from the complete historical set of scenarios (for instance, 8,760 scenarios corresponding to each hour of the considered year) with the results that different possible reduced sets of scenarios would provide. However, the present situation in data availability and data gathering procedures at the IEM level shows that it will take some time to be in a position so that such a comparison is feasible. Given the current scarcity of information on real network flows (i.e. the lack of complete and consistent data for a sufficient number of scenarios), the pragmatic alternative is to use for this purpose the annual hourly data on flows at IEM level that is currently available or that can be easily obtained. This is discussed in more detail in section 5.2.

C. *Computation of the inter-TSO payments.* Determination of the actual quantities (compensations and charges for each country) that allow one to establish the inter-TSO payments for a given year and to make regulatory decisions. This task requires the application of the selected network cost allocation algorithm to the complete IEM real network for the selected reduced set of scenarios.

What has been said above implies that the following categories of data will be needed to fully develop and implement the long term mechanism for inter-TSO payments:

1. *Data that describe the real network flows for a given scenario.* This includes the real power flows in each one of the lines, the generation and demand that is connected at each node and the description of the physical connectivity of the network facilities plus some characterization of these facilities. The electrical characteristics (impedances) of the lines and transformers are needed for those algorithms that are based on load flow computations. Commonly used power flow models, such as PSS, have standard data requirements for this purpose.

2. *Additional data for real network flow analysis*

Network branch data: length, voltage level, maximum capacity, type (in order to discriminate between double and single circuits and also between lines and transformers in case the transformers are represented as lines).

Nameplate capacity of generators.

3. *Data on simplified network flows for the determination of the reduced set of scenarios.* Hourly aggregated import and export flows at each border of every country (at least it would be advisable to have one value for the sum of all the import flows to the country at each border and another value for the sum of all the export flows at each border). This set of data has several applications:

Determination of the reduced set of scenarios.

Comparison of the results obtained from the different advanced methods with the results of the provisional approach.

Implementation of the method of simplified average participations (see section 3.1.2) for network cost allocation during a complete year.

Note that the data in bullets 1 and 3 are specific to each scenario. The data in bullet 2 are common to all the scenarios.

Estimation of future operating conditions in the IEM could also be of interest, in order to anticipate any major changes in inter-TSO payments may take place in the future and also to start the analysis of the treatment and impact on the results of future network reinforcements. In this regard, the following information would be needed:

Predicted increase in the capacity of major interconnectors for the next 5 to 10 years.

Load flow scenarios, at IEM level or just including a subset of the TSOs (countries), which could represent future flow patterns in the IEM, 5 to 10 years from now.

4.1.1 Sources of information

The present situation

The contractor formally contacted the European Association of Electricity Transmission System Operators (ETSO) in January 2002, regarding the current availability of data to perform the present study and also with respect to the future implementation of the long-term mechanism for inter-TSO payments. Shortly afterwards ETSO representatives indicated the willingness of ETSO to provide data for both purposes. This was officially confirmed by ETSO some time later, and therefore ETSO formally requested the data from their member organizations: UCTE, NORDEL and the TSOs of the UK and Ireland. Data for three UCTE scenarios were received in the second half of May 2002, as well as hourly data on aggregated imports and exports for a full year. Data, —corresponding to one out of the three UCTE scenarios—, for NORDEL and the TSOs of the UK and Ireland was received at the beginning of June 2002. Finally, a second version of data, —measured rather than estimated—, for the same UCTE scenario was received in the second half of June 2002.

In the course of these contacts, ETSO has indicated the major difficulties that exist in data collection for allocation of network costs in the context of the computation of inter-TSO payments:

- ETSO confirms that a load flow at IEM level requires consistent network and generation data of all the interconnected systems in order to provide meaningful results for any given operating condition. The required data to prepare a large number of scenarios exist at the individual TSO level. However, these data are not necessarily homogeneous, both in technical definition and data format, and it will require a significant amount of work to have this information ready in a common format and with a homogeneous meaning. In some cases there are even difficulties with having all the required data available in electronic format.
- Data exist for a small number of operating conditions for the networks of the organizations conforming ETSO: UCTE and NORDEL, plus the TSOs of UK and Ireland. However, the data for these networks have not been put yet together to conform the entire ETSO network model. The largest of these models is that of UCTE. UCTE comprises 18 countries, with about half of them belonging to the IEM. Only a few (about two per year at most, for the last 2 or three years) annual load flows at UCTE level are available. The situation is much better for NORDEL, as explained below.
- The information that is being gathered at UCTE so far is very limited. Just what is needed to run load flows. New data gathering procedures at ETSO level will be necessary if additional data that are not usual in other type of studies (such as line length) or a certain number of scenarios are required. The organizations within ETSO are mostly devoted to tasks related to system operation and security. This applies in particular to UCTE, the largest organization within ETSO. Network cost allocation has not been an issue for the UCTE and, consequently, the procedures and resources to collect and to handle the required data are not presently available.

- NORDEL has a long tradition of cooperation and pool operation among its members. As of January 1st 2002, NORDEL has started a procedure to compensate their members for the cost of losses incurred because of transits. The procedure is based on a real flows network model and makes use of hourly real flows for each hour of the year. This is the maximum amount of information that could be required by the algorithms that are examined in this report. This shows that having this information available is technically possible. It is however understood that a significant effort is needed in order to extend the data collection practices in NORDEL to the entire IEM and the UCTE in particular.
- In the future, ETSO will probably have most of the information that is necessary to satisfactorily apply the proposed algorithms as a sub-product of the coordinated congestion management scheme that has been proposed by ETSO itself. But this scheme may take some time to be implemented, —for sure more than one year—, and assuming that it is finally adopted. There are some network flow data that are being gathered since a few months ago for congestion management purposes on a daily or weekly basis and involving only some subsets of the IEM countries. As indicated before, ETSO considers that these data should not be used in the context of this project, since they correspond to estimations of future operating conditions and not to measurements from actual physical flows, as agreed at the Florence Forum.
- After the contacts that the EU Commission and the contractor established with ETSO since the beginning of this project, ETSO requested from its members an assessment on the volume of resources and the time delays that could be expected for the data collection effort. The results are expected to be available shortly.
- Confidentiality rules of the involved organizations may stipulate sharing any employed information & the results with any country whose information is used in the study. This might be a problem with non IEM countries. If this is the case, a pragmatic solution is not to use the data of those countries that are affected by this rule. This can be accomplished in the proposed algorithms by cutting the lines at the borders with non IEM countries and by replacing the flows by fictitious generators or loads that are conveniently placed in right locations at the borders.
- Standard network costs are also needed for the adopted network cost allocation procedure. ETSO initially collected data from its members in order to be able to establish standard cost values for transmission facilities, but the heterogeneity of the data made this a difficult task. Presently a Task Force within ETSO is in charge of making a recommendation on standard network costs.

In conclusion, the required data exist, in general they are theoretically available and they are routinely being collected in some of the IEM countries, exactly for the same purpose of network cost allocation. Sometime in the future ETSO will probably have this information available as a byproduct of its future coordinated congestion management scheme or just by direct collection for cross-border tariffication purposes, but this will not be on time for the foreseen implementation

of the long-term mechanism by January 2003. Therefore, the specification of the procedures for data collection by ETSO must start immediately.

Implications for the present study

The following line of action has been therefore adopted for the present study, given the scarcity of available information during the time frame of realization of the project:

- Place most of the effort on the validation of the concepts and the algorithms that will allow the recommendation of a methodology for network cost allocation with data that are currently available, in particular with the few scenarios of the 17-country UCTE network referred to above.
- Develop and implement the methodology for specification of the number of required scenarios, based on the already available hourly import and export flows for each country.
- Compute merely indicative figures for the compensations of network costs, network cost allocation factors and even ideal nodal network tariffs, based on the data for the few scenarios that may be made available during the realization of the project. Then the methodology will be ready once more data are made available.
- Propose some simplified or provisional implementation scheme of the methodology to be recommended, so that it might be implemented by the desired deadline (January 1st, 2003) with a workable effort in data gathering by the members of ETSO.

4.1.2 Data that have been used in this study

Scenarios of real network flows

UCTE has made available three complete load-flow scenarios that correspond to the actual operation of the system at different times³⁹. The times and dates for these scenarios are as follows:

1. Scenario 1 corresponds to January 17, 2001 at 10:30 am.
2. Scenario 2 corresponds to August 22, 2001, at 10:30 am.
3. Scenario 3 corresponds to January 16, 2002 at 10:30 am.

During the second half of June 2002, -when all of the numerical computations with the considered scenario were finished-, a new version of the same three scenarios was received from UCTE, corresponding to actually measured flows, instead of the estimated flows in the initial data files.

All these scenarios have been received in 'UCT' format and a translator program has been needed to obtain the PSS format data files that are used to run the

³⁹ It seems that the three scenarios that were sent in the first place correspond to estimates made by the system operators prior to real time and not to actual metered flows. Only the data for one of the scenarios was finally provided as a result of actual measurements.

algorithms. After having translated them into PSS format, some minor changes in the impedances of some lines had to be made in order to avoid some problems with zero impedance branches connecting generators which were not exactly at the same voltage. Some other changes, also connected to the line impedances had to be made in order to prevent the Jacobian matrix of the system from being poorly conditioned.

Hourly scenarios of simplified flow patterns

For the analysis on selection of scenarios that will be described in the next section, a data set of hourly net imports plus exports for the nine countries of the IEM belonging to the UCTE has been used.

4.2 Methodology to determine the reference scenarios

As indicated above, the proposed advanced algorithms for allocation of network costs and losses only need to be applied to a reduced set of historical power flows in the IEM network that are representative enough of the range of operating conditions of the considered year. In this section, and on the basis of the currently available information, an estimate of the number of scenarios that would be needed to obtain a robust answer to the cost allocation problem has been made and the methodology to accomplish this task is described.

All the methods that have been described in Chapter 4 must be applied to a single scenario defined by the generation and loads of all nodes and the flows of each power line. All these methods should be used to compute a cost and losses compensation for a complete year. Obviously this cannot be done by analyzing a single scenario that represents a single situation, although the scenario had been selected due to its special conditions: maximum load of the system, maximum exchange of energy, etc. Ideally, the exact solution should be obtained taking into account 8,760 scenarios corresponding to each one of the 8,760 hours that contains a year.

However, this solution may not be practical for the time being due to two main reasons. First, the data for all these scenarios may not be available for some time. Second, it might not be necessary to collect that much information, since it is likely that many of these scenarios will be very similar and the number of representative scenarios, consequently, small. Then, the goal of this task is to find a minimum set of scenarios that will provide a good approximation to the results that would be obtained with the full set of 8760 scenarios.

4.2.1 Proposed method

It will be assumed that only a small number of scenarios of real network flows can be collected and processed to determine the suitable coefficients for network cost allocation. The proposed method is meant to help in the a priori identification of this reduced set of scenarios.

Since the complete set of 8760 real network flows is assumed not to be available, it is necessary to find a suitable “proxy” of the real network flows for which: a) the complete set of 8760 cases is known, and b) there is a high degree of correlation with the feature of interest, namely, a measure of the external network use of some countries or TSOs. The only reasonable proxy that meets the aforementioned conditions is the import/export hourly flows of each country. This information is far more easy to obtain than the real network flows and intuitively it seems that it captures the essential conditions that result in the external utilization of a network.

Figure 9 graphically depicts what has been stated above. We start from the basic assumption that the simple patterns of hourly imports and exports for each country mostly determine the participation matrices of network cost allocation that are needed to compute the inter-TSO payments (see Table 1 in section 3.1). This means that the clusters of similar participation matrices and the clusters of similar patterns of net export and import border flows coincide. Therefore it is possible to determine clusters of net export and import border flows in order to identify a reduced set of scenarios of real network flows from which we could compute representative participation matrices for network cost allocation.

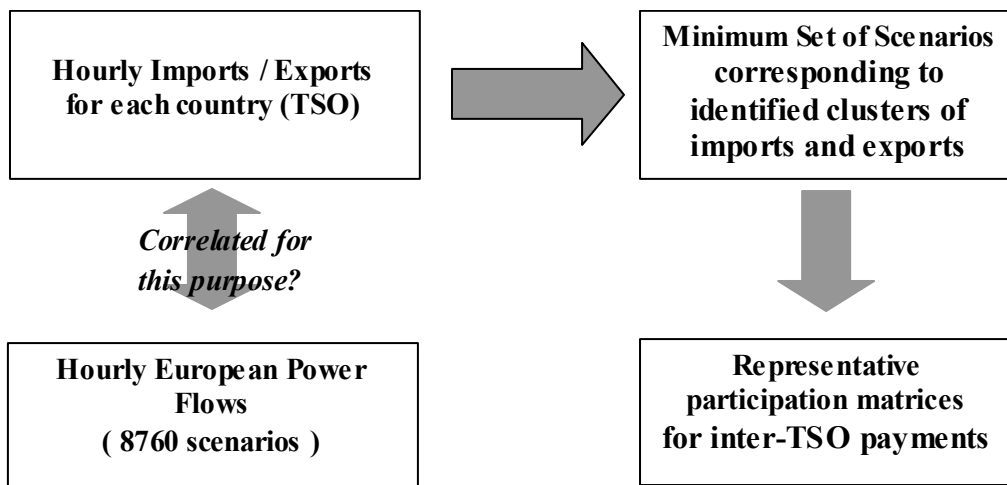

Figure 9: Selection of Scenarios

The application of this approach requires the completion of two steps: a) Find the patterns in the set of 8760 hourly import/export flows and, b) Prove that the reduced set of real network flows that are selected with this methodology give an accurate result.

In this report only the results for the first step are presented. For this study a data set of one full year of hourly net import and export flows for nine countries of continental Europe has been used, as provided by ETSO.

A competitive learning algorithm has been employed to find the different patterns in the input data. This is called usually “clustering” in the specialized literature of data-mining techniques. The competitive learning algorithm that has been selected here can be used to “cluster” correlated information in any multi-dimensional space

that is defined by a certain system. In this case the net border flows (exports – imports) for the 9 countries define a 9 dimensional space that contains 8760 vectors.

The aim of the learning process used here is to cluster the input data into a set of partitions such that the intra-cluster variance remains small compared with the inter-cluster variance.

The PRBFN algorithm [Muñoz 1996] is one out of the several ones that might be used. Each algorithm uses a different criteria in order to cluster the data. Later in this section, a second competitive learning algorithm is used in order to provide a comparison.

4.2.2 Discussion of the results

Two main results are obtained with the PRBFN algorithm: the reference vector of each cluster and the cluster which each one of the 8760 vectors belongs to. The number of clusters is defined by the user. This means that a trial and error procedure has to be employed with a different number of clusters until a reasonable result is achieved.

In this report a set of two possible solutions are shown, corresponding to a choice of 11 and 12 clusters. The results can only be seen graphically. For each solution two sets of figures are shown:

- A figure showing each reference vector (this vector is the representative of the cluster and it is not an actual vector) in blue and all vectors belonging to that cluster in yellow (since this number is usually quite large, only a yellow shape is seen). In this case the “x” axis represents all the vector components (2x9 flows) and the “y” axis represents the flow in MW. This figure provides a tool to easily spot how homogeneous are the clusters and how well each reference vector “represents” its cluster members.
- A color map showing the cluster each vector belongs to. The “x” axis corresponds to the 24 hours in a day and the “y” axis corresponds to the 365 days of a year. The color map makes it possible to identify some patterns by inspection. That will become clear later, once the case example has been shown.

The results that have been obtained are presented next.

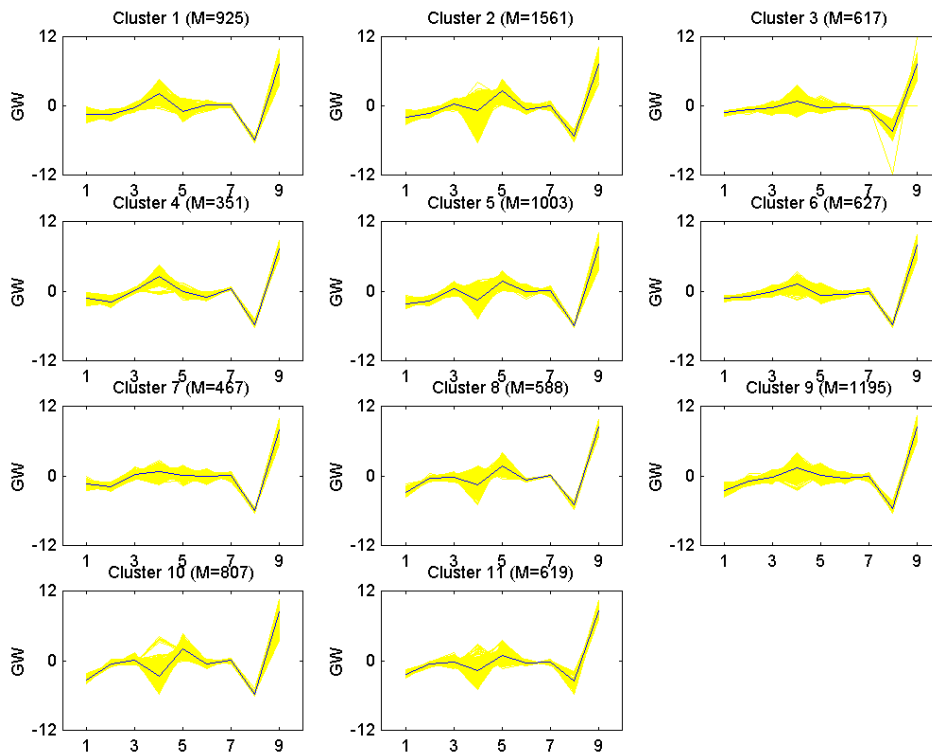

Figure 10: Graph of type 1 for 11 clusters

The number of vectors of each cluster is indicated above each graph (M). It can be easily seen that patterns 2, 5 and 8 are very similar. Both of them have a very close reference vector and all its members are very close to them. The same occurs with patterns 3 and 6, for example. However, only clusters 4, 7 and 6 have very homogeneous members (small yellow area). The remaining clusters have more variability in their members.

A preliminary conclusion can be drawn: the patterns of net border export and import flows are surprisingly very similar. The reason for this is that the reference vectors of each cluster have a similar shape and also that in each cluster the members are very close to their reference vectors.

In the following figure a similar result is given for the case with 12 clusters. It can be noticed that with more clusters the groups become more homogeneous. The flow patterns are still very similar.

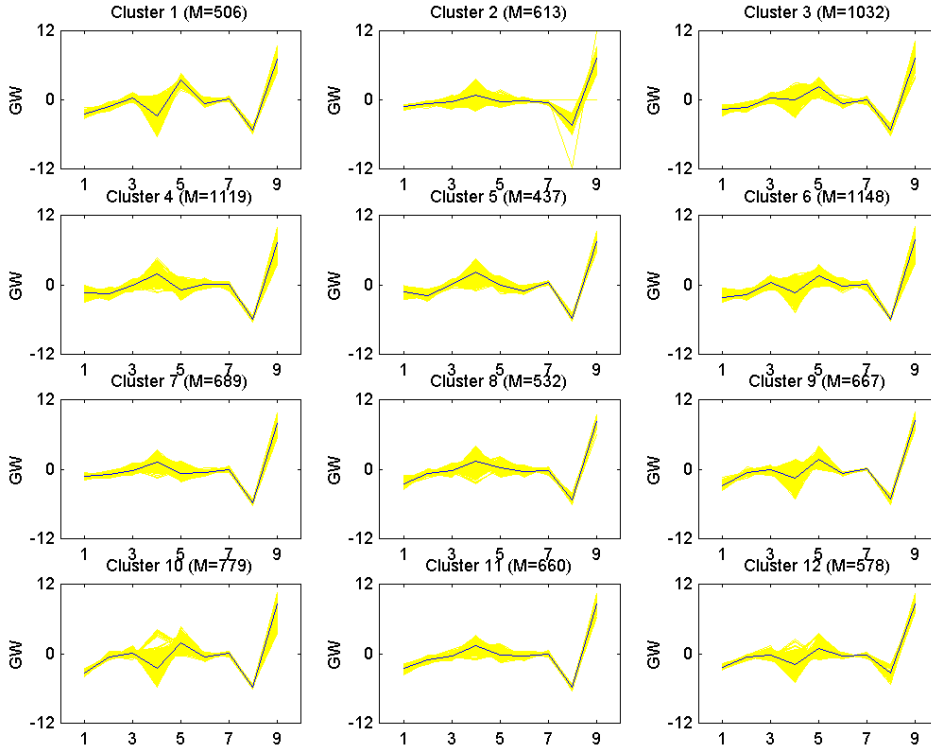

Figure 11: Graph of type 1 for 12 clusters

Next, type-2 graphs are presented. This type of graph is designed to show the possible correlation between hours, days and clusters. Each graph shows the membership of each hourly vector (net border flows of 9 countries).

The results are quite interesting because the color map confirms that there is an important correlation between the type of exchange pattern, the hour and the month/day/season. For example, in the first figure it can be easily seen that there is a clear different pattern between the first hours of each day (from 00 to 07 hours) and the rest. Also, the final hours (around 23 – 24 hours) have a pattern that is similar to the one of the first hours. Other different patterns can be detected along the 365 days of the year. For example, for the first hours of the day 5 different patterns are clearly shown: July— October⁴⁰, October-January, January-middle of March, Middle of March-April, April-May and May-July. Slightly different patterns can be seen for the later hours of the day. For example, in the later hours the weekend hours can be detected.

⁴⁰ The year starts on the 1st of July and ends by the 30th of June

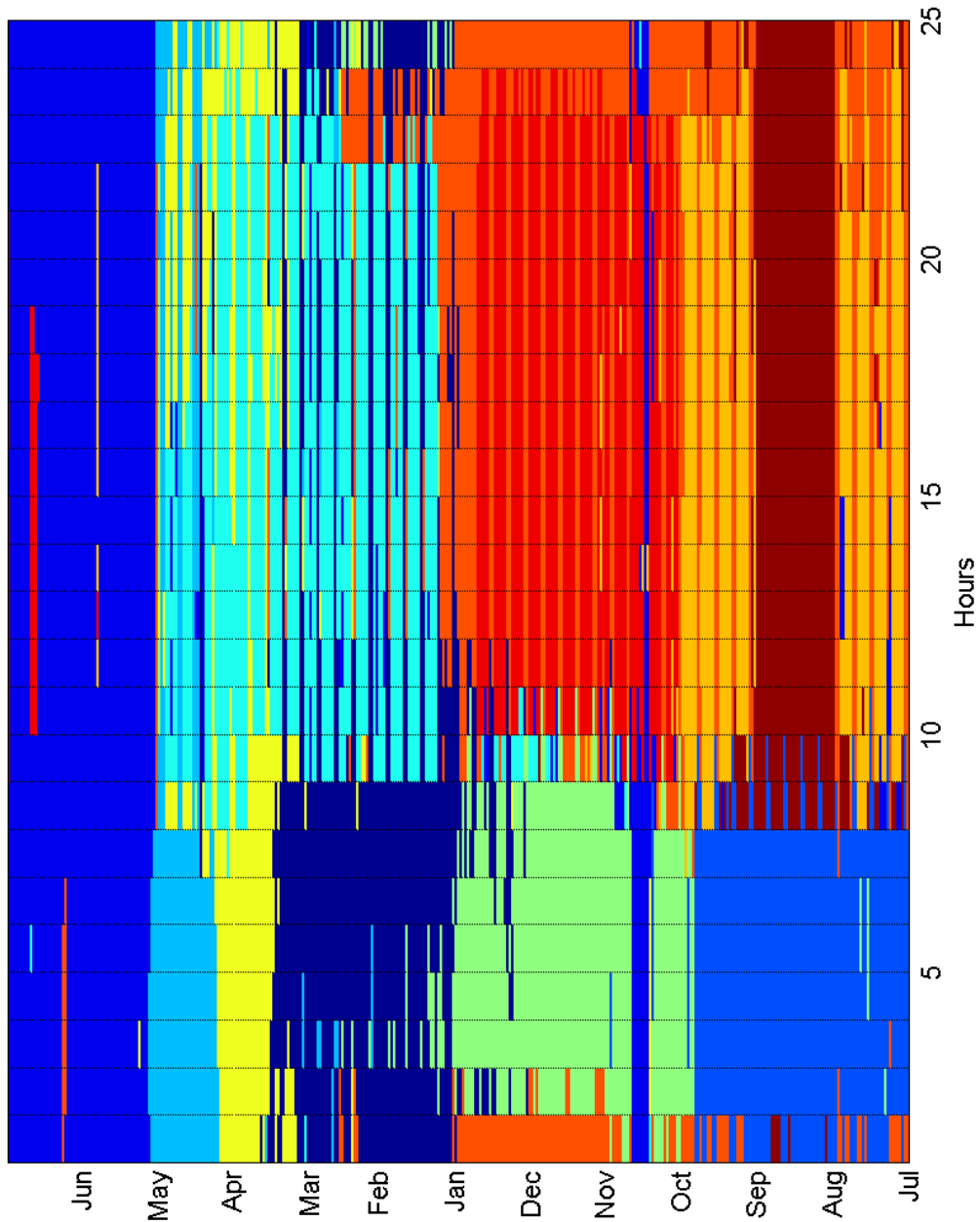

Figure 12: Graph #2 for 11 clusters

The following figure represents the same result but now with 12 clusters. Some important differences can be found. For example, with 12 clusters, the early hours of March seem to be more homogeneous than with 11 clusters. Also, a new cluster appears within the period from May to July that is not present in the 11-cluster case. But this is not the only change, since other areas appear to be better defined with 12 clusters than with 11, although the changes might not be deemed significant.

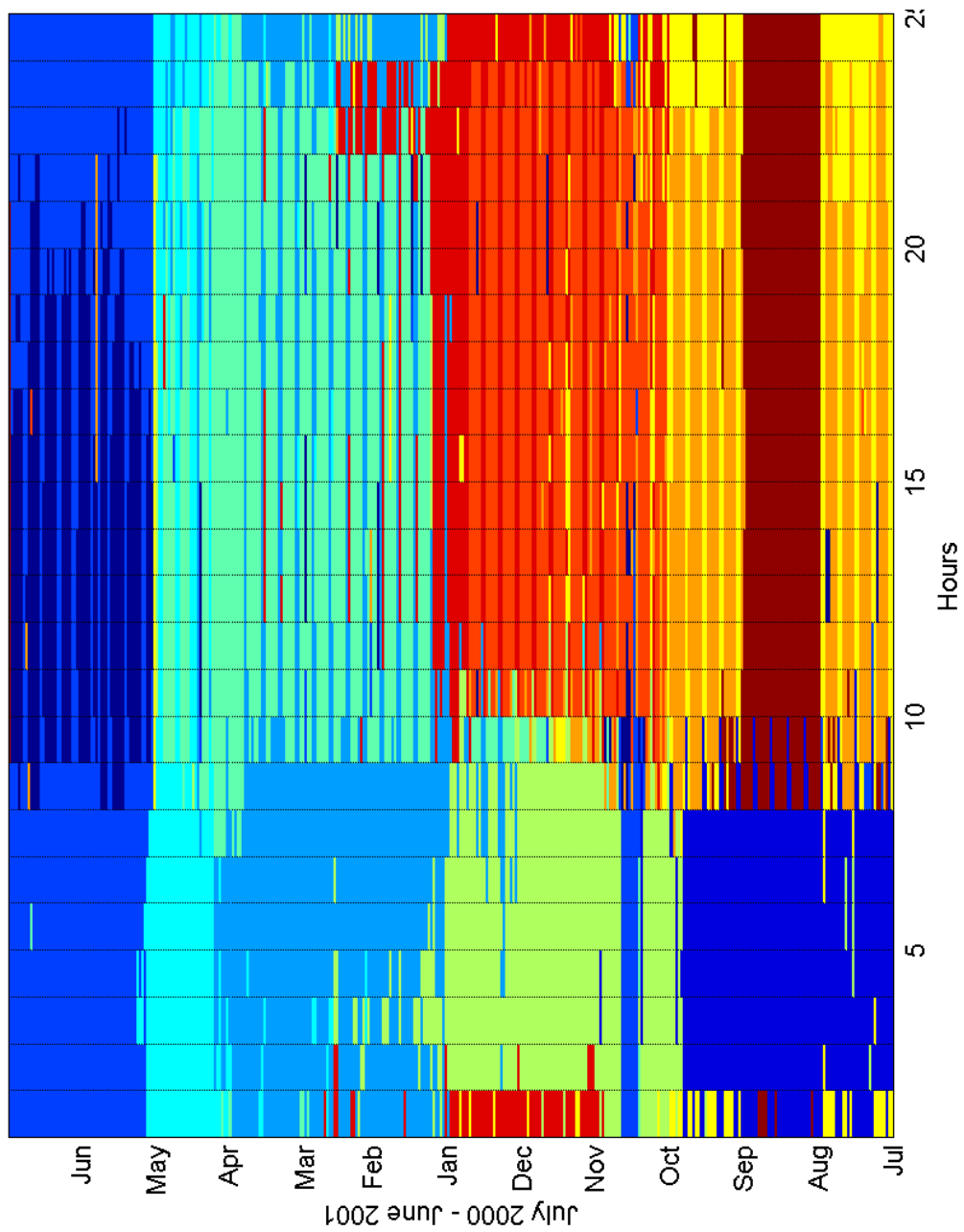

Figure 13: Graph #2 for 12 clusters

For the sake of clarity, Figure 14 and Figure 15 have been included. In these figures it is possible to examine each cluster separately.

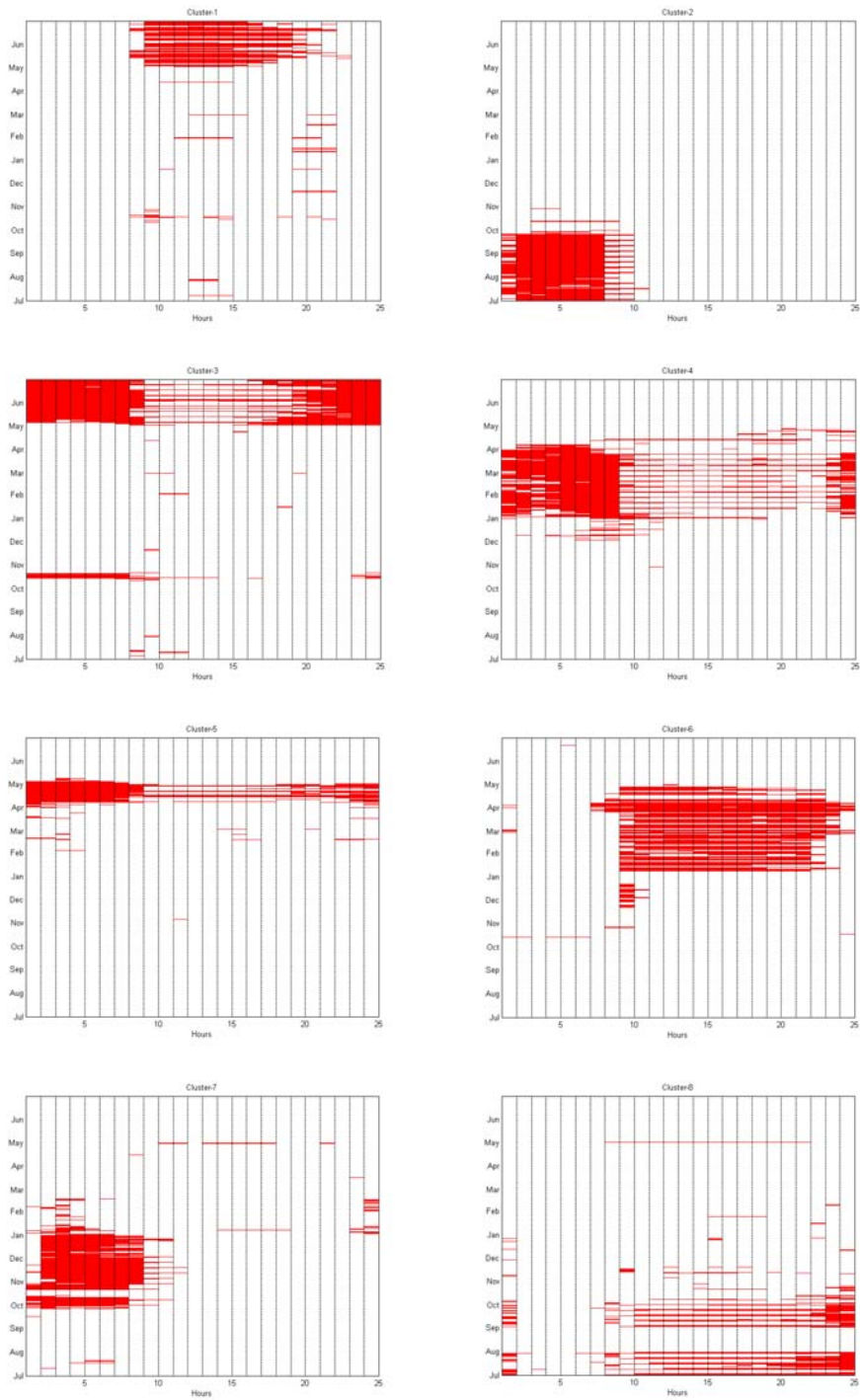

Figure 14: Each one of the 12 clusters (I)

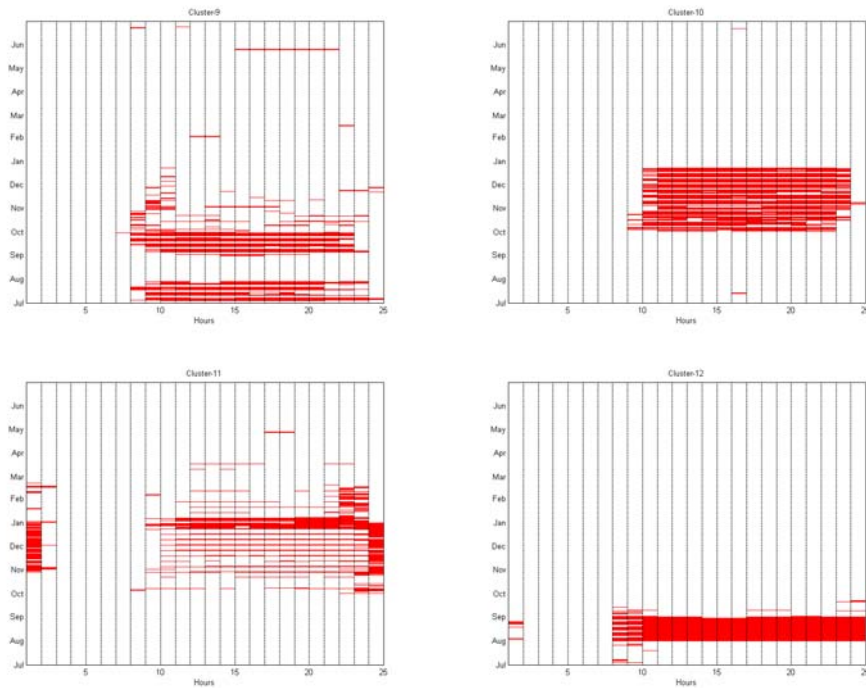

Figure 15: Each one of the 12 clusters (II)

The final conclusion that can be derived from this cluster analysis is that a set of 11 or 12 scenarios can be enough to accurately evaluate the cost compensations due to energy exchanges. However, it has to be noted that this will only be true once it is proved that the hourly energy exchanges between countries are highly correlated to real network flows, just for the purpose of determining the participation matrices for the computation of inter-TSO payments.

Cluster ID	Day	Month	Hour
1	4th Tuesday	May	16
2	3rd Thursday	Sep	6
3	2nd Friday	May	24
4	1st Sunday	Feb	14
5	2nd Tuesday	Apr	2
6	2nd Tuesday	Feb	12
7	2nd Monday	Nov	4
8	4th Sunday	Sep	21
9	4th Monday	Jul	14
10	3rd Thursday	Nov	11
11	4th Saturday	Dec	19
12	3rd Saturday	Aug	17

Table 2: A plausible set of scenarios

The final goal of this analysis is to define a set of minimum scenarios. It is possible to find the actual vector of exports and imports that is closest to the synthetic one

(the representative vector for each cluster). In the accompanying table the scenarios that have been finally selected are presented.

These scenarios are able to represent all members of their respective clusters, but they are not the only possible election. As it can be seen in Figure 13, the identified patterns are also valid for many hours and days. This can be explained because the net imports and exports happen to be more stable than the internal fluctuations of the internal generation and demand at country level. For example, an import could be set to the maximum capacity of the interconnection during a large fraction of the day, and it might happen to be fairly independent from the load level evolution of the importing or exporting country. No distinction between workday and weekend scenarios are needed, according to the obtained results. Weekend days (or only Sundays) can be assimilated to patterns corresponding to early hours of normal days.

5 Quantitative analysis of methods for cost allocation

This chapter presents the numerical results that have been obtained by application of the different algorithms that were described in chapter 3 to the available scenarios of real network flows.

The evaluation of the results will be more detailed for the two methods that are more representative of the two families of algorithms that were described in chapter 3: the method of average participations (AP) and the “with and without transits” method (WWT). The discussion of the remaining methods is always done as a comparison with the AP and WWT methods. The evaluation will basically concentrate on the results that have been obtained for the allocation of the costs of network infrastructure, in the understanding that the decision about the algorithm on the allocation of losses will be conditioned by the previous one. In fact, the results that have been obtained show that the economic value of the compensations because of losses are much lower than the compensations for infrastructure. The proportion depends strongly on the considered method. Thus, while for the AP method the ratio of infrastructure-related to loss-related inter-TSO payments is about 4 to 1, in others like the WWT method it is about 3 to 1. For compensations only (before applying charges) this same ratio is about 3 to 1 for most of the methods. However, it is the net inter-TSO payments what really matters.

For each one of the methods of allocation of infrastructure costs, the results on compensations and charges are presented by means of a table, which is identical to the one that was described in section 3.1 for the prototype algorithm. A detailed explanation of the meaning of all the numbers in the standard table was also provided in section 3.1. Note that in the tables E stands for Spain, P for Portugal, F for France, I for Italy, CH for Switzerland, D for Germany, B for Belgium, NL for The Netherlands, SLO for Slovenia, A for Austria, CZ for the Czech Republic, PL for Poland, BIH for Bosnia, HR for Croatia, H for Hungary, SK for the Slovak Republic and UA for Ukraine⁴¹.

5.1 The considered scenarios

Data requirements and availability have been commented in chapter 4. Due to the scarcity of officially provided data on scenarios of real network flows, the analysis that is reported in this chapter basically refers to a single case: the UCTE model for January 17th, 2001, at 10:30 am., with values that were estimated by the several system operators. This is exactly the same approach that has been adopted

⁴¹ The results for Ukraine are not representative, as the country’s electric system has not been really modeled and only one equivalent generator and one small demand have been placed at the borders with Hungary and the Slovak Republic.

by ETSO in its internal appraisal of the available algorithms⁴². It has been considered by ETSO, and also in this study, that a single scenario of a large meshed network model with 17 countries is enough to make an assessment of most of the pros and cons of the different algorithms and to make suggestions on the most suitable methodology for network cost allocation in the inter-TSO payment context⁴³.

Once a methodology for network cost allocation has been decided, it is possible to reduce the UCTE model to the countries that presently participate in the IEM by collapsing the remaining ones into a “perimeter countries” equivalent system, and the systems of NORDEL, UK and Ireland could be connected to the modified UCTE model⁴⁴. It is expected that these tasks will be greatly facilitated once ETSO establishes the procedures to collect and process the data in a systematic fashion.

The results that are shown for compensations and losses are not expressed in monetary terms, since the information to do so is not yet available. On one hand, the data on the length of the lines in the model has not been provided, and it cannot be inferred from the line reactances, since more than 5% of the lines of the model do not correspond to physical lines but to fictitious equivalent lines and therefore their physical parameters have no value to estimate line lengths. On the other hand, we would also need to know the standard costs for 1 km of 400 kV lines, —perhaps different standard costs could be used under different circumstances, such as the climate or the type of terrain—, for 1 km of 220 kV lines, for 1 km of 132 kV lines and also for transformers.

In order to address the problem of the lack of data on line lengths and standard network costs, the following decisions have been adopted: a) all lines will be considered of equal length; b) based on available cost information, it will be assumed that 1 km of a line of 220 kV is equivalent to 0.66 km of a line of 400 kV, and 1 km of a line of 132 kV is equivalent to 0.44 km of a line of 400 kV; c) for the time being, some transformers have been considered as lines of 400 kV, while others as lines of 220 kV or as lines of 132 kV. In this way all the results of charges and compensations can be expressed in terms of number of lines of 400 kV.

⁴² There is another data set, also corresponding to the same day and time, but with values that were obtained from direct measurements, also by the system operators. ETSO has officially worked with this one, while in this project we have worked with the one that was first provided officially, which is based on estimations. Unfortunately, the differences between both sets of data are significant, so the numerical results cannot be directly compared.

⁴³ Some of the algorithms have been also applied to the UCTE scenario for January 19th, 2000, at 10:30 am. However, it has been noticed that the network model for this scenario is fairly different from the one used in the scenario corresponding to January 17th, 2001. For instance, the Spanish grid is represented by approximately 3 times less branches in the case corresponding to January 19th, 2000 than in one corresponding to January 17th, 2001. This renders the comparison of the results of the two algorithms very difficult.

⁴⁴ Data for NORDEL, UK and Ireland for January 17, 2002, at 10 am have been received from ETSO at a later date. The NORDEL system has been used to establish an additional comparison between the APT and the AP algorithms. See Annex 7 for details.

The scenario of January 17th, 2001, at 10:30 am.

Figure 16 depicts the import and export flows between the different countries in a schematic representation of the UCTE system, as well as the aggregated generation and demand for each country.

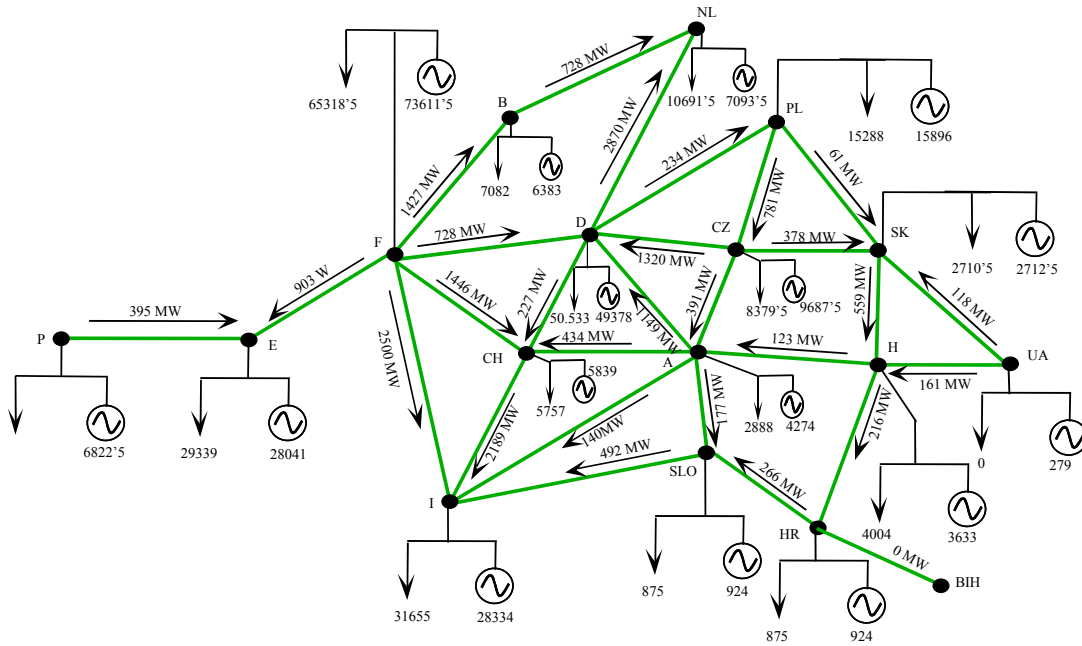

Figure 16: Aggregated data for the considered UCTE scenario

These figures are also summarized in Table 3, where the number of generation nodes and demand nodes is also indicated, as well as the net export value for each country and the value of the transit, according to the definition of ETSO, see section 3.1.5. It must be realized that the sum of the export flows from a country according to Figure 16 is not the same as the total amount of export flows in Table 3. This is because in Figure 16 only one line has been represented between each pair of countries that are electrically connected and, consequently, import and export flows on the different lines between these two countries have been netted. Only the net import or export between each pair of countries has been represented. The considered UCTE model as a whole has 3,655 lines and 3,383 nodes, with a total amount of production equal to 244.00 GW, a total load of 240.86 GW and losses of 3.14 GW.

Country	Name	Demand	Generation	#D	#G	Exports	Imports	Net E-I	ETSO-T
E	Spain	29,090	28,289	197	103	554	1,851	-1,298	554
P	Portugal	6,364	6,891	35	20	755	361	395	361
F	France	64,804	74,126	677	184	8,487	193	8,293	193
I	Italy	31,480	26,508	217	112	0	5,321	-5,321	0
CH	Switzerland	5,720	5,877	53	37	2,686	2,604	82	2,604
D	Germany	50,150	49,649	367	93	3,887	5,042	-1,155	3,887
B	Belgium	7,170	6,405	31	12	1,053	1,752	-699	1,053
NL	Netherlands	10,651	7,134	34	14	325	3,923	-3,597	325
SLO	Slovenia	820	929	4	3	814	764	50	764
A	Austria	2,814	3,905	20	20	1,961	577	1,385	577
CZ	Czech Rep.	8,194	9,836	32	16	2,099	791	1,308	791
PL	Poland	15,449	16,032	106	29	843	235	608	235
BIH	Bosnia	316	671	6	7	146	146	0	146
HR	Croatia	995	1,122	7	7	733	684	50	684
H	Hungary	4,146	3,619	24	7	373	725	-352	373
SK	Slovak Rep.	2,616	2,759	24	10	569	567	3	567
UA	Ukraine	84	250	1	1	279	29	250	29

Data in MW

Table 3: Aggregated data for the considered UCTE scenario

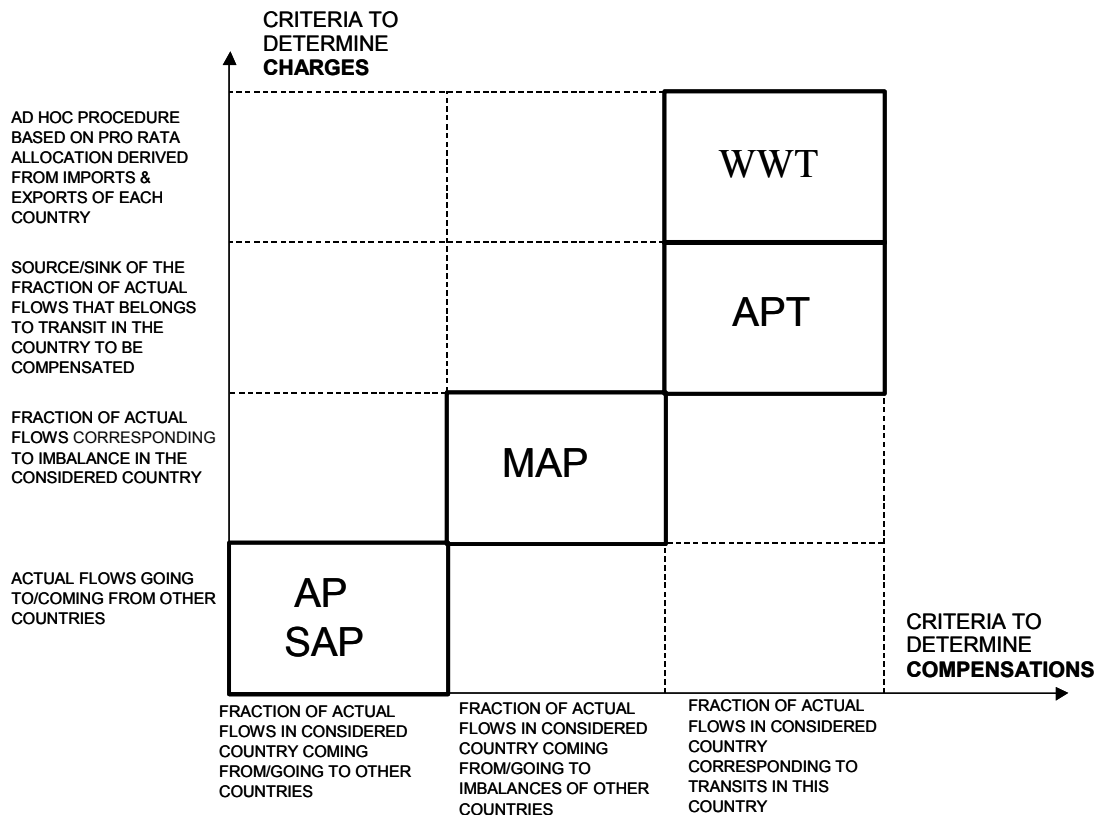

Figure 17: . Criteria to determine compensations and charges for the considered algorithms

5.2 Compensations and charges because of network utilization

Six different methods will be considered here when computing the economic compensations and charges that each country must be paid or receive as a consequence of the adopted inter-TSO payment mechanism. These are the same six methods whose description and critique were presented in Chapter 3. The most basic features of each one of them, —except for the method of marginal participations (MP)—, are summarized in Figure 17.

Family 1: Algorithms that are based on the network utilization of individual agents and complete actual cross-border flows

5.2.1 Algorithm 1: Average participations (AP)

The results for compensations and charges

Table 4 presents the results of compensations and charges that are obtained with the AP method. The meaning of all the numbers in the table has been already explained in section 3.1. Figures in Table 4 represent percentages of the total volume of the grid. Table 5 and Table 6 show the same results as Table 4 when figures represent number of lines and millions of euros respectively. In order to obtain the later results it has been necessary to consider a standard length for the lines and a standard remuneration that the owner of transmission lines will be paid per kilometer of 400 kV line⁴⁵. The values of 50 Km⁴⁶ and 0.01306 million euros per Km of 400 kV line, respectively, have been adopted here. In other words, every line of the system has been considered to be 50 Km long and to receive a remuneration of 0.653 million euros.

⁴⁵ A standard value corresponding to the Spanish system has been used, this value is approximately half the average value of the ones provided by some ETSO members for the period from 98/10-01 to 99/09/30. These ETSO members are the ones for which the data were available except Belgium and Switzerland whose costs were much higher than the rest of them,

⁴⁶ A standard value for the length of the lines in the system has been obtained by estimating the length of the lines in the system from their reactance. In order to do so typical values for the reactance of 400 kV, 220 kV and 132 kV lines being 100 Km long have been considered and compared to the ones of the real lines of the system. Lines being equivalent to a subsystem have not been taken into account in the calculation process, these lines have been detected as those whose reactance was higher than 0.1 p.u.

	E	P	F	I	CH	D	B	NL	SLO	A	CZ	PL	BIH	HR	H	SK	UA		
E	10.43	0.11	0.19	0.00	0.00	0.00	0.00	0.00	0.00	0.00	0.00	0.00	0.00	0.00	0.00	0.00	0.00	10.73	0.30
P	0.19	2.01	0.00	0.00	0.00	0.00	0.00	0.00	0.00	0.00	0.00	0.00	0.00	0.00	0.00	0.00	0.00	2.20	0.19
F	0.16	0.00	29.26	0.40	0.33	0.45	0.13	0.00	0.00	0.00	0.00	0.00	0.00	0.00	0.00	0.00	0.00	30.74	1.48
I	0.00	0.00	0.34	11.29	0.49	0.01	0.00	0.00	0.02	0.05	0.00	0.00	0.00	0.10	0.01	0.00	0.00	12.31	1.02
CH	0.00	0.00	0.15	0.24	2.60	0.19	0.00	0.00	0.00	0.02	0.00	0.00	0.00	0.00	0.00	0.00	0.00	3.20	0.60
D	0.00	0.00	0.04	0.00	0.22	22.46	0.01	0.30	0.00	0.20	0.08	0.09	0.00	0.00	0.00	0.00	0.00	23.40	0.94
B	0.00	0.00	0.15	0.00	0.00	0.01	2.06	0.08	0.00	0.00	0.00	0.00	0.00	0.00	0.00	0.00	0.00	2.30	0.24
NL	0.00	0.00	0.00	0.00	0.00	0.23	0.08	1.58	0.00	0.00	0.00	0.00	0.00	0.00	0.00	0.00	0.00	1.89	0.31
SLO	0.00	0.00	0.00	0.01	0.00	0.00	0.00	0.00	0.22	0.06	0.00	0.00	0.00	0.03	0.00	0.00	0.00	0.31	0.10
A	0.00	0.00	0.00	0.04	0.06	0.16	0.00	0.00	0.03	1.15	0.02	0.00	0.00	0.00	0.02	0.01	0.00	1.49	0.35
CZ	0.00	0.00	0.00	0.00	0.00	0.25	0.00	0.00	0.00	0.07	1.28	0.04	0.00	0.00	0.00	0.06	0.00	1.71	0.43
PL	0.00	0.00	0.00	0.00	0.00	0.05	0.00	0.00	0.00	0.00	0.07	6.54	0.00	0.00	0.00	0.04	0.00	6.70	0.16
BIH	0.00	0.00	0.00	0.00	0.00	0.00	0.00	0.00	0.00	0.00	0.00	0.00	0.21	0.02	0.00	0.00	0.00	0.23	0.02
HR	0.00	0.00	0.00	0.03	0.00	0.00	0.00	0.00	0.05	0.01	0.00	0.00	0.08	0.28	0.02	0.00	0.00	0.47	0.20
H	0.00	0.00	0.00	0.01	0.00	0.00	0.00	0.00	0.01	0.01	0.01	0.00	0.00	0.01	1.00	0.07	0.02	1.13	0.13
SK	0.00	0.00	0.00	0.00	0.00	0.00	0.00	0.00	0.00	0.01	0.03	0.05	0.00	0.00	0.05	0.95	0.01	1.10	0.15
UA	0.00	0.00	0.00	0.00	0.00	0.00	0.00	0.00	0.00	0.00	0.00	0.00	0.00	0.00	0.02	0.04	0.01	0.08	0.06
	10.73	2.20	30.74	12.02	3.71	23.80	2.28	1.96	0.33	1.58	1.48	6.72	0.29	0.44	1.13	1.17	0.05		
	0.05	-0.08	-0.61	-0.29	0.51	0.40	-0.02	0.07	0.01	0.09	-0.22	0.02	0.06	-0.04	0.01	0.07	-0.03		
	0.35	0.11	0.87	0.73	1.11	1.34	0.22	0.39	0.11	0.44	0.21	0.18	0.08	0.16	0.13	0.22	0.03		
	0.30	0.19	1.48	1.02	0.60	0.94	0.24	0.31	0.10	0.35	0.43	0.16	0.02	0.20	0.13	0.15	0.06		

Table 4: Compensations and charges with the AP method, figures are expressed as a percentage of the total volume of the grid

	SPA	POR	FRA	ITA	SWI	GER	BEL	NED	SVE	AUS	CZE	POL	BOS	CRO	HUN	SVA	UKR		
SPA	382	4	7	0	0	0	0	0	0	0	0	0	0	0	0	0	0	393	11
POR	7	74	0	0	0	0	0	0	0	0	0	0	0	0	0	0	0	81	7
FRA	6	0	1071	15	12	16	5	0	0	0	0	0	0	0	0	0	0	1125	54
ITA	0	0	12	413	18	1	0	0	1	2	0	0	0	4	0	0	0	451	37
SWI	0	0	5	9	95	7	0	0	0	1	0	0	0	0	0	0	0	117	22
GER	0	0	2	0	8	822	0	11	0	7	3	3	0	0	0	0	0	857	35
BEL	0	0	5	0	0	0	76	3	0	0	0	0	0	0	0	0	0	84	9
NED	0	0	0	0	0	8	3	58	0	0	0	0	0	0	0	0	0	69	11
SVE	0	0	0	0	0	0	0	0	8	2	0	0	0	1	0	0	0	12	4
AUS	0	0	0	1	2	6	0	0	1	42	1	0	0	0	1	1	0	55	13
CZE	0	0	0	0	0	9	0	0	0	3	47	2	0	0	0	2	0	63	16
POL	0	0	0	0	0	2	0	0	0	0	3	240	0	0	0	2	0	245	6
BOS	0	0	0	0	0	0	0	0	0	0	0	0	8	1	0	0	0	8	1
CRO	0	0	0	1	0	0	0	0	2	0	0	0	3	10	1	0	0	17	7
HUN	0	0	0	0	0	0	0	0	0	0	0	0	0	1	37	2	1	41	5
SVA	0	0	0	0	0	0	0	0	0	0	1	2	0	0	2	35	0	40	6
UKR	0	0	0	0	0	0	0	0	0	0	0	0	0	0	1	1	1	3	2
	395	78	1103	440	136	871	84	72	12	58	54	246	11	16	41	43	2	3661	
	393	81	1125	451	117	857	84	69	12	55	63	245	8	17	41	40	3		
	2	-3	-22	-11	19	15	-1	3	0	3	-8	1	2	-1	0	3	-1		
	13	4	32	27	41	49	8	14	4	16	8	7	3	6	5	8	1		
	11	7	54	37	22	35	9	11	4	13	16	6	1	7	5	6	2		

Table 5: Compensations and charges with the average participations method when figures are expressed in number of lines

Same results could have been obtained with the rest of the methods but it has not been considered to be necessary.

The analysis

The numbers in Table 4 appear to make engineering and economic sense. An almost purely exporting country, such as France with 8,487 MW of exports and 193 MW of imports, participates in the utilization of the networks of neighboring countries, such as Spain (0.16), Italy (0.40), Switzerland (0.33), Germany (0.45) and Belgium (0.13). On the other hand, several importing countries use the French network, such as Spain (0.19), Italy (0.34), Switzerland (0.15) Germany (0.04) and Belgium (0.15), yielding a total compensation to France because of the external utilization of its network of 0.87. Since the global utilization by France of other networks equals 1.48, the net inter-TSO payment for France is -0.61. Since this is a negative number, this means that French network users owe 0.61% of the total

number of lines in the UCTE model to a common fund to compensate other countries for the external utilization of their networks. Of course, this is just one winter peak load scenario and the final numbers could be quite different once a representative number of scenarios are evaluated.

	E	P	F	I	CH	D	B	NL	SLO	A	CZ	PL	BIH	HR	H	SK	UA		
E	249.3	2.6	4.6	0.0	0.0	0.0	0.0	0.0	0.0	0.0	0.0	0.0	0.0	0.0	0.0	0.0	0.0	256.4	7.2
P	4.6	48.0	0.0	0.0	0.0	0.0	0.0	0.0	0.0	0.0	0.0	0.0	0.0	0.0	0.0	0.0	0.0	52.6	4.6
F	3.9	0.0	699.5	9.6	8.0	10.6	3.2	0.1	0.0	0.0	0.0	0.0	0.0	0.0	0.0	0.0	0.0	734.8	35.3
I	0.0	0.0	8.1	270.0	11.8	0.3	0.0	0.0	0.5	1.2	0.0	0.0	0.0	2.3	0.3	0.0	0.0	294.4	24.4
CH	0.0	0.0	3.5	5.8	62.2	4.4	0.0	0.0	0.0	0.6	0.0	0.0	0.0	0.0	0.0	0.0	0.0	76.5	14.4
D	0.0	0.0	1.0	0.1	5.3	536.9	0.1	7.1	0.0	4.8	2.0	2.1	0.0	0.0	0.0	0.0	0.0	559.4	22.5
B	0.0	0.0	3.5	0.0	0.0	0.2	49.3	2.0	0.0	0.0	0.0	0.0	0.0	0.0	0.0	0.0	0.0	55.0	5.7
NL	0.0	0.0	0.0	0.0	0.0	5.5	2.0	37.7	0.0	0.0	0.0	0.0	0.0	0.0	0.0	0.0	0.0	45.1	7.4
SLO	0.0	0.0	0.0	0.2	0.0	0.0	0.0	0.0	5.2	1.5	0.0	0.0	0.0	0.7	0.0	0.0	0.0	7.5	2.4
A	0.0	0.0	0.0	0.8	1.5	3.9	0.0	0.0	0.7	27.4	0.4	0.0	0.0	0.1	0.6	0.3	0.0	35.7	8.3
CZ	0.0	0.0	0.0	0.0	0.0	5.9	0.0	0.0	0.0	1.8	30.5	1.0	0.0	0.0	0.1	1.5	0.0	40.8	10.3
PL	0.0	0.0	0.0	0.0	0.0	1.2	0.0	0.0	0.0	0.0	1.6	156.4	0.0	0.0	0.0	1.0	0.0	160.2	3.8
BIH	0.0	0.0	0.0	0.0	0.0	0.0	0.0	0.0	0.0	0.0	0.0	0.0	5.0	0.5	0.0	0.0	0.0	5.5	0.5
HR	0.0	0.0	0.0	0.8	0.0	0.0	0.0	0.0	1.2	0.2	0.0	0.0	2.0	6.6	0.5	0.0	0.0	11.3	4.7
H	0.0	0.0	0.0	0.1	0.0	0.0	0.0	0.0	0.1	0.2	0.1	0.0	0.0	0.3	23.8	1.6	0.6	26.9	3.1
SK	0.0	0.0	0.0	0.0	0.0	0.0	0.0	0.0	0.0	0.3	0.8	1.2	0.0	0.0	1.2	22.8	0.2	26.4	3.6
UA	0.0	0.0	0.0	0.0	0.0	0.0	0.0	0.0	0.0	0.0	0.0	0.0	0.0	0.0	0.6	0.9	0.3	1.8	1.5
	257.7	50.6	720.3	287.4	88.7	569.0	54.6	46.9	7.8	37.9	35.5	160.7	6.9	10.4	27.0	28.1	1.1		
	256.4	52.6	734.8	294.4	76.5	559.4	55.0	45.1	7.5	35.7	40.8	160.2	5.5	11.3	26.9	26.4	1.8		
	1.2	-2.0	-14.6	-7.0	12.1	9.5	-0.5	1.8	0.3	2.2	-5.4	0.5	1.4	-0.8	0.1	1.7	-0.7		
	8.4	2.6	20.8	17.4	26.5	32.1	5.3	9.2	2.6	10.4	5.0	4.3	2.0	3.9	3.2	5.3	0.8		
	7.2	4.6	35.3	24.4	14.4	22.5	5.7	7.4	2.4	8.3	10.3	3.8	0.5	4.7	3.1	3.6	1.5		

Table 6: Compensations and charges with the average participations method when figures are expressed in millions of euros

A similar interpretation can be given when the figures for a purely importing country, such as Italy with no exports and 5,321 MW of imports, are examined. Italy also has to face a net payment of 0,29. The situation is quite different for an almost purely transited country, such as Switzerland, with 2,686 MW of exports and 2,604 MW of imports. Although Switzerland has to compensate other countries for a total amount of 0.60, it must be compensated by a total of 1,11, therefore resulting in a positive net payment of 0.51. Note that, despite all the concerns about “comparatively small, well balanced and heavily transited countries” the AP method, at least for the considered scenario, ends up with a positive net payment for Switzerland. This is also the case for other almost purely transited countries, such as Slovenia, Bosnia and the Slovak Republic, although Croatia has to pay (it has a slightly net exporting balance). Other cases are a mixture of exports, imports and transits and they are more difficult to assess.

Other results

Particular attention has been paid to the AP method, as indicated above. This is why a detailed analysis has been carried out to find out the range of dispersion of the participations of the network users in the lines of the network. In other words, we wanted to know whether the nodes that participate in the utilization of a line are close to the line or they could be located very far (electrically) from the line. Figure 18, Figure 19 and Figure 20 provide such an information. All 3,383 nodes in the network are represented in the horizontal axis and all 3,655 lines in the vertical axis. There is a dot in Figure 18 when a node has a non zero participation in a line. Dots are blue for generation nodes and red for demand nodes. In order to avoid problems with black and white copies of this report, Figure 19 only shows the

red (demand) dots and Figure 20 only the blue (generation) ones. With France being an exporting country, it makes sense that red dots do not extend outside France while the blue ones reach as far as Spain, Italy, Switzerland, Germany or Belgium⁴⁷. The darker line that appears in the figure indicates that the ordering of the lines and nodes in the UCTE files respects proximity; thus, there is a higher density of dots in the nodes that are closest to the lines.

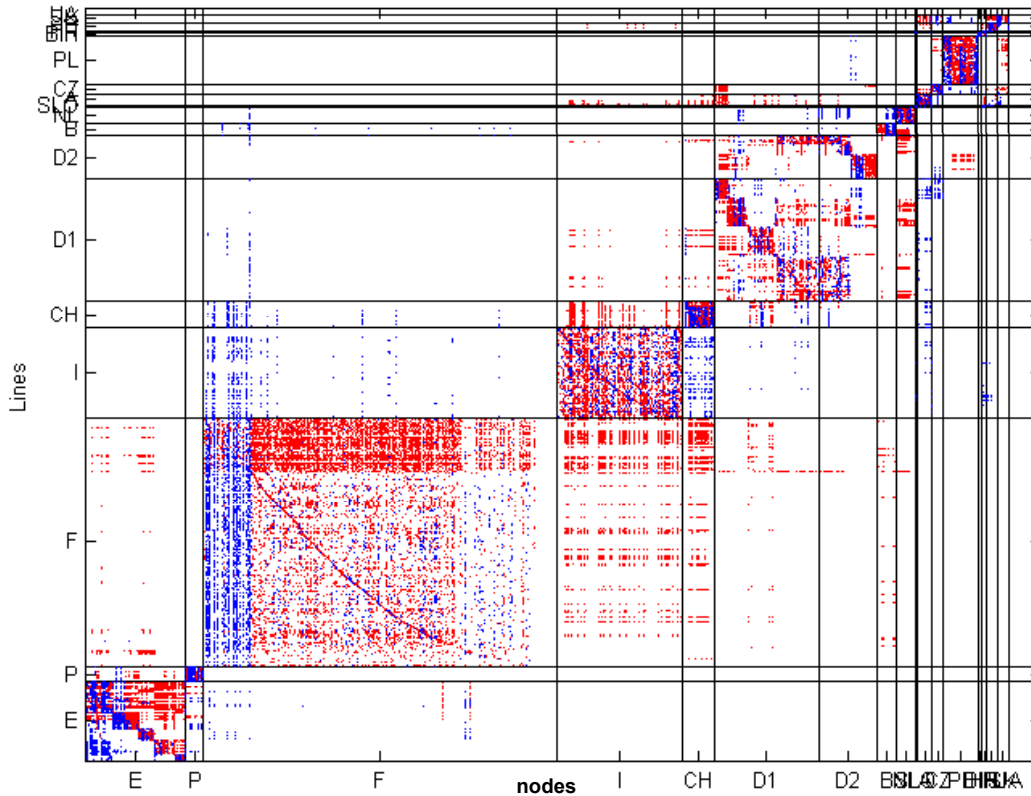

Figure 18: Participation of generation and demand nodes in the lines

⁴⁷ In this table there are two regions in Germany, according to the organization of the UCTE provided files.

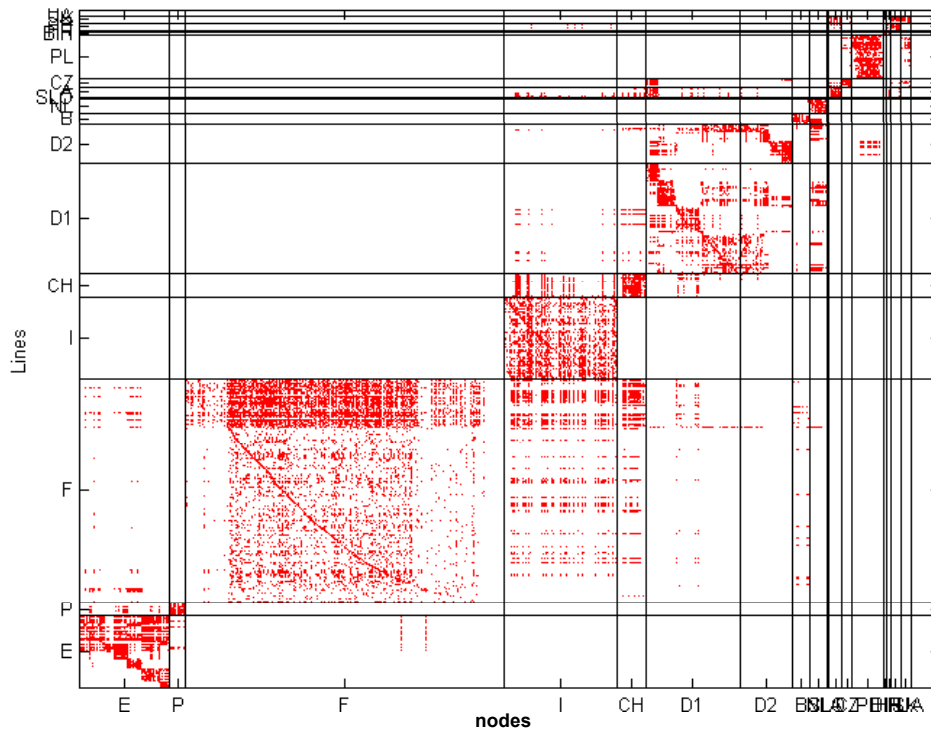

Figure 19: Participation of demand nodes in the lines

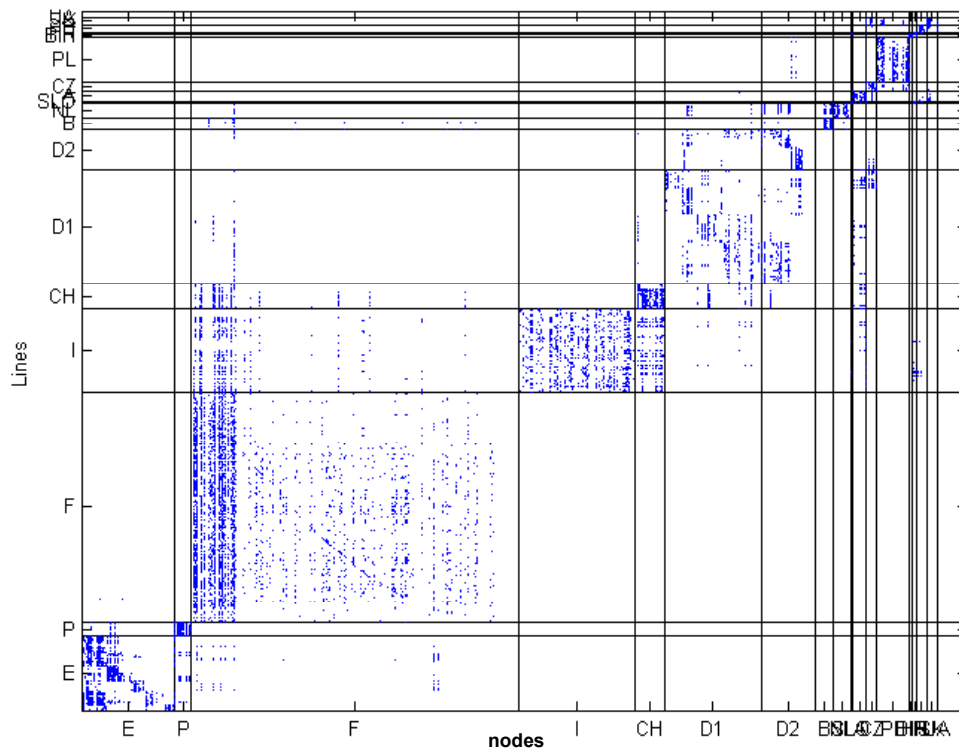

Figure 20: Participation of generation nodes in the lines

Figure 21 and Figure 22 are in agreement with other expected result: the numerical value of the participations fade out as the nodes get further away from the considered lines. Figure 21 does not represent all the dots, but only those with a value higher than 10% in the flow participation, while Figure 22 includes only the dots with a value higher than 20%. It is apparent that the higher the threshold in the participation value the closer the dots are to the corresponding lines and they rarely expand beyond the country where the line is located.

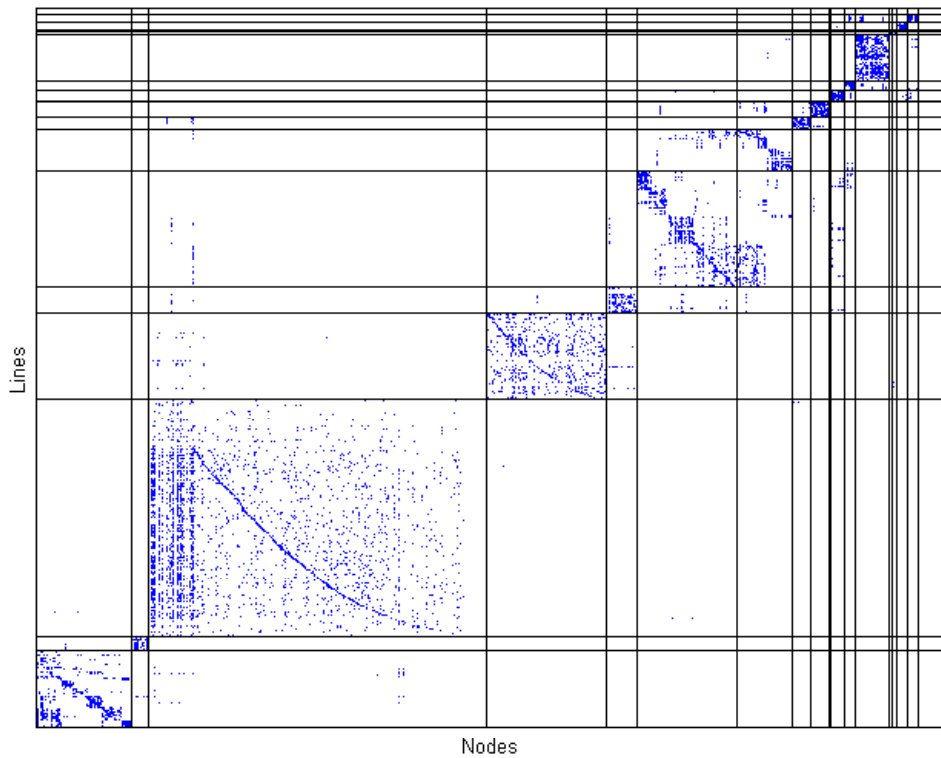

Figure 21: Participations > 10% for both generators and demands in the lines

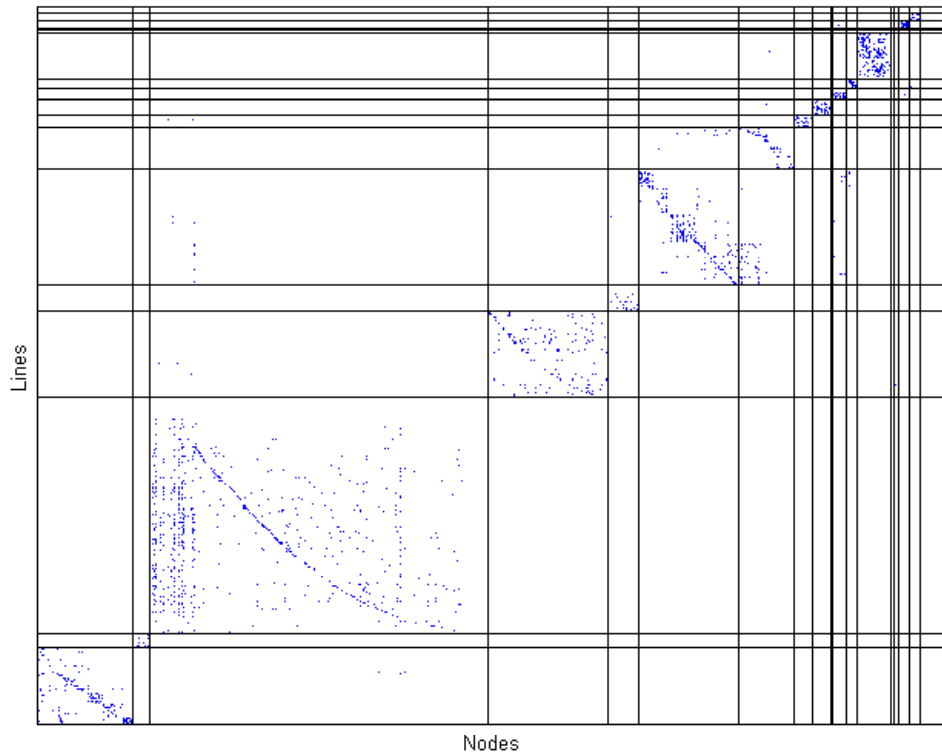

Figure 22: Participations > 20% for both generators and demands in the lines

From the observation of the previous graphs it can be seen that some nodes participate of a large number of lines. In many cases, the participation is very low in the majority of the lines⁴⁸.

The results of the AP method provide useful indications on how to charge or credit the net amount of inter-TSO payment of a country j to the consumers and generators within that country. In fact, the AP method precisely determines how much the generators in country j are using of the network external to j , and also how much of the network of country j is being used by generators from outside country j . The excess of the first amount over the second one is the extra payment (or credit, if the amount is negative) that should be charged to the generators in country j . These locational signals are weaker than they should ideally be, since the average value for country j is used instead of the individual value for each generator. The same reasoning should be used for consumers⁴⁹. The same

⁴⁸ However, and this has been detected by examination of the output files of the computer model, some nodes (for example, two generators in France) are the main users (responsible for more than the 50% of the flow) of many lines. A more detailed analysis shows that most of these lines have a very low flow. For instance, one of these nodes happens to be allocated a line completely because it uses the only 5 MW flowing through that line.

⁴⁹ Note that, when a country is exporting its generators use the external networks of other countries. Conversely, when a country is importing its loads use the external networks of other countries. Therefore, an alternative solution that is broadly consistent with the more precise allocation scheme that has just been described (although one wonders why to use an approximation when the more accurate solution is available) is the following one:

treatment applies to the inter-TSO payments that are derived from compensations for losses.

Table 7 shows the results of applying these ideas to the results of the considered scenario.

Country	Pay to L	Pay to G
<i>E</i>	-0.17	0.22
<i>P</i>	0.01	-0.10
<i>F</i>	0.84	-1.44
<i>I</i>	-1.02	0.73
<i>CH</i>	0.31	0.20
<i>D</i>	-0.02	0.42
<i>B</i>	-0.09	0.08
<i>NL</i>	-0.29	0.36
<i>SLO</i>	-0.03	0.04
<i>A</i>	0.28	-0.19
<i>CZ</i>	0.08	-0.31
<i>PL</i>	0.06	-0.04
<i>BIH</i>	0.02	0.04
<i>HR</i>	0.03	-0.07
<i>H</i>	-0.04	0.04
<i>SK</i>	0.00	0.07
<i>UA</i>	0.02	-0.05

Table 7: Allocation of inter-TSO payments to the tariffs G and L (% of European Network)

Finally, the results of the AP method allow the computation of the participation factors for any line k in the system, i.e., the cost of line k can be assigned to a

- If the net outcome for a country is a charge: Allocate the charge to all generators (increase G) and to all consumers (increase L) in the same proportion that the country has exported or imported, respectively, during the last year. E.g. if the net annual outcome of inter-TSO payments for country j is 5 m€, and if country j has been a net exporter during a number of hours in the year for a total amount E (kWh), and also a net importer during the remaining hours for a total amount I (kWh), then a fraction $E/(E+I)$ of the 5 m€ should be charged to the G tariff (i.e. to all generators in country j) and the remaining fraction $I/(E+I)$ should be charged to the L tariff (i.e. to all consumers in country j).
- If the net outcome for a country is a credit: Allocate the credit to all generators (decrease G) and to all consumers (decrease L) in the same proportion that the country has imported or exported, respectively, during the last year.

Let us now verify that the same heuristic rule also applies for losses. What effects would losses have on the network users? Start with a reference situation with multiple interconnected TSOs where, for simplicity, it will be assumed that each one has a single market price (instead of multiple nodal prices). In the absence of congestions and network losses, and with fully developed international trading mechanisms, the market prices for all TSOs should be the same. With congestions and no losses, there would be several subsets of TSOs separated from one another by congestions and where the prices of the TSOs in any subset would also be the same.

The effect of adding losses to this reference model would roughly be to lower the market price in the exporting TSOs and to increase the price in the importing TSOs. Then, in order to represent approximately the same effect with the modifications to G & L because of inter-TSO payments, one should apply the same set of rules that has been described above.

subset of the network users. This property can be exploited in the future when new reinforcements are being planned in the IEM network. While at the planning stage, the AP model can be run and it will be determined how much of the cost of the reinforcement will have to be born by the generators and consumers of every country in the IEM. This may help in having the reinforcement built.

It is convenient to go back to the basics in section 2.1.1 for a moment. These additional uses of the AP method would be only totally justified if AP were a “perfect” method for network cost allocation. But it is not. The AP method is probably the best we can do at the present moment, but it is no more than a reasonable heuristic proxy to an ideal network cost allocation method. The more confidence we have in the AP method the more tasks we can rely upon it.

Computer implementation notes

All the algorithms in this study that, in one way or another, are related to the method of average participations, have used in their implementation a common software module: ‘MEPAM.C’. This module takes as an input a certain set of data files corresponding to a load-flow scenario and it applies the average participations method to determine how much each one of the agents, —consumers or generators—, which are included in the scenario participates in the flow on each line. This module was developed well before the present project started and it has been programmed using ‘C’ language⁵⁰.

The following steps must be followed in order to apply the AP method:

- A load flow model that will be termed here an IPLAN program (which has been written in the programming language of the power system analysis package PSS) generates the data files for the considered scenario that are needed in the subsequent steps of the process. Note that, in a standard implementation of the AP method, there is no need for a load flow model. The input to the MEPAM.C program, or any other package of computation of average participations, is just a snapshot of the flows in the considered network.
- ‘MEPAM.C’, from the data files that have just been mentioned, determines the flow on each one of the lines of the system each one of the network users is responsible for.
- Finally, another ‘C’ program determines, from the flow on each line each agent is responsible for, the utilization factors of each agent in each line. Then, from these utilization factors, it is computed the use that each country is making of the grid of all the countries in the system, including itself. This is accomplished by aggregating the participations that have been obtained in the previous step of the process.

⁵⁰ MEPAM.C was developed in the context of the doctoral thesis of Prof. Rubio, see [Rubio et al., 2000] and [Pérez-Arriaga et al., 1995].

5.2.2 Algorithm 2: Simplified average participations (SAP)

The results for compensations and charges

Table 8 presents the results of compensations and charges that are obtained with the SAP method. The meaning of all the numbers in the table has been already explained in section 3.1.

	E	P	F	I	CH	D	B	NL	SLO	A	CZ	PL	BIH	HR	H	SK	UA		
E	10.54	0.06	0.18	0.00	0.00	0.00	0.00	0.00	0.00	0.00	0.00	0.00	0.00	0.00	0.00	0.00	0.00	10.79	0.24
P	0.07	2.05	0.00	0.00	0.00	0.00	0.00	0.00	0.00	0.00	0.00	0.00	0.00	0.00	0.00	0.00	0.00	2.12	0.07
F	0.17	0.00	28.40	0.55	0.34	0.45	0.21	0.02	0.00	0.00	0.00	0.00	0.00	0.00	0.00	0.00	0.00	30.13	1.73
I	0.00	0.00	0.59	11.03	0.51	0.01	0.00	0.00	0.06	0.06	0.00	0.00	0.00	0.02	0.00	0.00	0.00	12.28	1.25
CH	0.00	0.00	0.21	0.31	2.72	0.04	0.00	0.00	0.00	0.05	0.00	0.00	0.00	0.00	0.00	0.00	0.00	3.33	0.61
D	0.00	0.00	0.39	0.01	0.05	22.12	0.00	0.24	0.00	0.18	0.09	0.04	0.00	0.00	0.00	0.00	0.00	23.13	1.01
B	0.00	0.00	0.26	0.00	0.00	0.00	1.96	0.06	0.00	0.00	0.00	0.00	0.00	0.00	0.00	0.00	0.00	2.28	0.32
NL	0.00	0.00	0.05	0.00	0.00	0.64	0.10	1.64	0.00	0.01	0.01	0.00	0.00	0.00	0.00	0.00	0.00	2.45	0.81
SLO	0.00	0.00	0.00	0.06	0.00	0.00	0.00	0.00	0.21	0.02	0.00	0.00	0.00	0.03	0.00	0.00	0.00	0.33	0.11
A	0.00	0.00	0.00	0.06	0.09	0.23	0.00	0.01	0.02	1.19	0.02	0.00	0.00	0.00	0.01	0.00	0.00	1.62	0.43
CZ	0.00	0.00	0.00	0.01	0.01	0.29	0.00	0.01	0.00	0.06	1.29	0.13	0.00	0.00	0.01	0.06	0.00	1.86	0.57
PL	0.00	0.00	0.00	0.00	0.00	0.05	0.00	0.00	0.00	0.01	0.06	6.50	0.00	0.00	0.00	0.02	0.00	6.63	0.13
BIH	0.00	0.00	0.00	0.00	0.00	0.00	0.00	0.00	0.00	0.00	0.00	0.00	0.29	0.00	0.00	0.00	0.00	0.29	0.00
HR	0.00	0.00	0.00	0.02	0.00	0.00	0.00	0.00	0.03	0.00	0.00	0.00	0.00	0.36	0.02	0.00	0.00	0.43	0.07
H	0.00	0.00	0.00	0.00	0.00	0.01	0.00	0.00	0.01	0.02	0.01	0.00	0.00	0.03	1.00	0.09	0.01	1.18	0.18
SK	0.00	0.00	0.00	0.00	0.00	0.00	0.00	0.00	0.00	0.00	0.02	0.02	0.00	0.00	0.06	0.98	0.01	1.09	0.11
UA	0.00	0.00	0.00	0.00	0.00	0.00	0.00	0.00	0.00	0.00	0.00	0.00	0.00	0.00	0.02	0.02	0.02	0.06	0.04
	10.78	2.11	30.09	12.04	3.72	23.83	2.27	1.97	0.33	1.59	1.49	6.70	0.29	0.43	1.13	1.18	0.04		
	10.79	2.12	30.13	12.28	3.33	23.13	2.28	2.45	0.33	1.62	1.86	6.63	0.29	0.43	1.18	1.09	0.06		
	-0.01	-0.01	-0.04	-0.24	0.39	0.69	-0.01	-0.48	0.00	-0.03	-0.37	0.07	0.00	0.01	-0.05	0.09	-0.02		
	0.24	0.06	1.70	1.01	1.00	1.70	0.31	0.33	0.11	0.40	0.20	0.20	0.00	0.08	0.13	0.20	0.02		
	0.24	0.07	1.73	1.25	0.61	1.01	0.32	0.81	0.11	0.43	0.57	0.13	0.00	0.07	0.18	0.11	0.04		

Table 8: . Compensations and charges with the SAP method

The analysis

The SAP method tries to obtain similar results to the AP method, but with a simpler model (just one node per country) for which there should be no data acquisition problems and no need to specify any representative set of scenarios (since there would be no difficulty in using 8,760 hourly scenarios per year).

Unfortunately, the results for inter-TSO payments that have been obtained with the SAP method cannot be considered to be a reasonable approximation to the results of the AP method. Although the compensations and the charges, when considered separately, show an interesting resemblance in both methods, when the difference between compensations and charges is computed in order to obtain the inter-TSO payments the similarity is spoiled.

Of course, it can be correctly argued that the SAP method is certainly superior to the present provisional method, but this is no excuse to use SAP when there is the possibility of using AP, at least in the medium term.

Other results

The SAP method cannot be used to compute nodal tariffs or to allocate the costs of a new network investment.

Computer implementation notes

As in the case of AP, the results that are obtained for SAP are based on the utilization of the 'MEPAM.C' module. The main difference is that now this module is not applied to a set of files corresponding to the real system but to a simplification of it where each country is represented by a single node, a super-node.

The following steps must be followed in order to apply the SAP method:

First, an IPLAN program is run that generates the set of files used by 'MEPAM.C'. As it has been already mentioned, these files are corresponding to the simplified model of the system being each country represented by a single node.

Secondly, 'MEPAM.C' is applied to this set of files so as to obtain the participations of each country in each of the lines of the simplified system. Now these lines represent the inter-connectors between each pair of countries. Therefore the participations of each country in the flow on the inter-connectors of the system are computed.

Finally another 'C' program generates the participation of each country in the use of the grid of every country in the system, including itself, taking as an input the participations of the country in the inter-connectors of the system. These participations are obtained as the ratio of the flow through the super-node the considered country is responsible for to the total flow going through it.

5.2.3 Algorithm 3: Modified average participations (MAP)*The results for compensations and charges*

Table 9 presents the results of compensations and charges that are obtained with the MAP method. The meaning of all the numbers in the table has been already explained in section 3.1.

The analysis

In the MAP method the use that a country j makes of the networks of other countries is computed in such a way that the external flows that are produced by country j are only those that result from its internal imbalance between load and generation. This is tantamount to removing from the external flows of country j the transit flows of country j , when the ETSO definition is followed. This has several interesting implications:

- i) The total volume of compensations to all countries is lower than in the AP method, since only country imbalances are used to compute the external flows. This can be easily checked by inspection of the second row from the bottom in Table 4 and Table 9.
- ii) Countries with no transits, —i.e. purely importing or exporting countries, such as Italy or (almost) France—, will be allocated exactly the same

charges for external network use than in the AP method, since the external flows are the same. This can be easily checked by comparing the rows for Italy or France in Table 4 and Table 9.

- iii) Countries that are purely transited, and therefore with no internal imbalances, will not be assigned any external use. This is almost exactly the case of Switzerland, Bosnia or the Slavik Republic, and that can be verified examining the corresponding rows in Table 9. Obviously this is not a surprise, since this is exactly the purpose of the MAP method.

	E	P	F	I	CH	D	B	NL	SLO	A	CZ	PL	BIH	HR	H	SK	UA			
E	10.56	0.05	0.13	0.00	0.00	0.00	0.00	0.00	0.00	0.00	0.00	0.00	0.00	0.00	0.00	0.00	0.00	0.00	10.73	0.18
P	0.07	2.06	0.00	0.00	0.00	0.00	0.00	0.00	0.00	0.00	0.00	0.00	0.00	0.00	0.00	0.00	0.00	0.00	2.13	0.07
F	0.14	0.00	29.67	0.44	0.34	0.44	0.13	0.00	0.00	0.00	0.00	0.00	0.00	0.00	0.00	0.00	0.00	0.00	31.16	1.49
I	0.00	0.00	0.34	11.53	0.49	0.02	0.00	0.00	0.02	0.05	0.00	0.00	0.00	0.10	0.01	0.00	0.00	0.00	12.55	1.02
CH	0.00	0.00	0.00	0.01	2.77	0.01	0.00	0.00	0.00	0.00	0.00	0.00	0.00	0.00	0.00	0.00	0.00	0.00	2.79	0.02
D	0.00	0.00	0.01	0.00	0.02	22.83	0.00	0.00	0.00	0.04	0.02	0.01	0.00	0.00	0.00	0.00	0.00	0.00	22.93	0.10
B	0.00	0.00	0.06	0.00	0.00	0.00	2.05	0.01	0.00	0.00	0.00	0.00	0.00	0.00	0.00	0.00	0.00	0.00	2.11	0.07
NL	0.00	0.00	0.00	0.00	0.00	0.23	0.07	1.93	0.00	0.00	0.00	0.00	0.00	0.00	0.00	0.00	0.00	0.00	2.23	0.30
SLO	0.00	0.00	0.00	0.00	0.00	0.00	0.00	0.00	0.27	0.00	0.00	0.00	0.00	0.00	0.00	0.00	0.00	0.00	0.28	0.01
A	0.00	0.00	0.00	0.03	0.06	0.14	0.00	0.00	0.03	1.44	0.00	0.00	0.00	0.00	0.01	0.00	0.00	0.00	1.70	0.26
CZ	0.00	0.00	0.00	0.00	0.00	0.17	0.00	0.00	0.00	0.05	1.41	0.00	0.00	0.00	0.00	0.05	0.00	0.00	1.67	0.26
PL	0.00	0.00	0.00	0.00	0.00	0.00	0.00	0.00	0.00	0.00	0.05	6.74	0.00	0.00	0.00	0.04	0.00	0.00	6.82	0.08
BIH	0.00	0.00	0.00	0.00	0.00	0.00	0.00	0.00	0.00	0.00	0.00	0.00	0.29	0.00	0.00	0.00	0.00	0.00	0.29	0.00
HR	0.00	0.00	0.00	0.00	0.00	0.00	0.00	0.00	0.00	0.00	0.00	0.00	0.00	0.34	0.00	0.00	0.00	0.00	0.35	0.01
H	0.00	0.00	0.00	0.00	0.00	0.00	0.00	0.00	0.00	0.00	0.00	0.00	0.00	0.00	1.09	0.04	0.01	1.14	0.05	0.00
SK	0.00	0.00	0.00	0.00	0.00	0.00	0.00	0.00	0.00	0.00	0.00	0.00	0.00	0.00	0.00	1.02	0.00	1.02	1.02	0.00
UA	0.00	0.00	0.00	0.00	0.00	0.00	0.00	0.00	0.00	0.00	0.00	0.00	0.00	0.00	0.03	0.04	0.04	0.10	0.10	0.06
	10.77	2.11	30.21	12.01	3.68	23.82	2.25	1.94	0.32	1.58	1.48	6.74	0.29	0.44	1.14	1.17	0.05			
	10.73	2.13	31.16	12.55	2.79	22.93	2.11	2.23	0.28	1.70	1.67	6.82	0.29	0.35	1.14	1.02	0.10			
	0.03	-0.02	-0.95	-0.54	0.89	0.89	0.14	-0.29	0.05	-0.11	-0.19	-0.08	0.00	0.09	-0.01	0.16	-0.05			
	0.21	0.05	0.54	0.48	0.90	0.99	0.21	0.01	0.05	0.14	0.07	0.01	0.00	0.10	0.05	0.16	0.01			
	0.18	0.07	1.49	1.02	0.02	0.10	0.07	0.30	0.01	0.26	0.26	0.08	0.00	0.01	0.05	0.00	0.06			

Table 9. Compensations and charges with the MAP method

As a consequence of what has been said, the positive inter-TSO payments (credits) to balanced or nearly balanced countries will increase (since they have lower compensations but almost zero charges), while negative inter-TSO payments (net charges) to almost purely exporting or importing countries will also increase (since they now have less compensations and the same charges). If the results of the AP method are used as the reference for a comparison, it can be checked, for instance, that Italy and France are worse-off and Switzerland is better-off with the MAP method, as expected and intended with the design of the method.

Other results

The MAP method has been designed very specifically for the needs of the inter-TSO payment mechanism and not as a general purpose method for the computation of nodal transmission tariffs or the allocation of the cost of a new investment. It is not immediate, to say the least, to find other applications to the results of the MAP method.

Computer implementation notes

Here ‘MEPAM.C’ is applied to a modified representation of the real system as in the previous case. A different network model has to be considered when computing the participations of each one of the countries in the grid of the others. In the MAP method, the grid of the country *j* whose external impact is being considered is represented only by just one node, with the imbalance of the internal generation

and demand of the country. The rest of the system, as well as the tie-lines between country j and its neighbors, are represented in full detail.

The following steps must be followed in order to apply the MAP method:

First an IPLAN program is used to generate the files that, for each one of the considered countries, correspond to the modified representation of the real system that has been just explained. Thus a different set of files for each country is obtained, where the country is represented by a 'collapsed' node and the rest of the countries are represented in detail.

Then 'MEPAM.C' is sequentially applied to each one of the different sets of files that have been mentioned in the previous point. In this way the participations of each country in the rest of the system are computed.

Finally another 'C' program is run to obtain, by aggregating the participations in the flows of the different lines, the use that each country is making of the grid of others. The local use that a country makes of its own network is simply computed as the difference between the total volume of its network and the use of it that has been made by other countries.

5.2.4 Algorithm 4: Marginal participations (MP)

The results for compensations and charges

The results that have been obtained with the marginal participations method show that, both considering a distributed slack bus or only one node as the slack, most of the agents have non-negligible participations in the flow of very distant lines. We only show here the numerical results corresponding to the participations of two sample agents in the flow of every line in the system. One of the agents is located in Palmela (Portugal) and the other one in Frankfurt. When computing the participation factors, for each one of the two agents both a distributed slack bus and a slack bus located at one specific node of the system (which has been chosen to be KKPILI in Germany) have been used. In the first case all the loads in the system respond homothetically to 50% of the variation in the power injected or withdrawn by the agent that is considered in the example and all the generators respond to the other 50%.

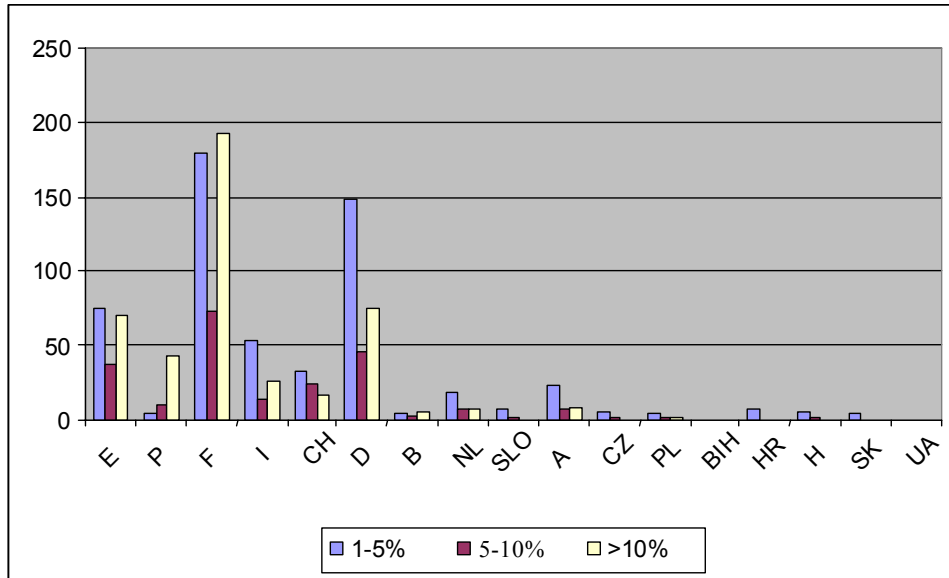

Figure 23: participations of the node 6006, which is located in Portugal, in the flows on the lines using the marginal participations method when only one node is considered as the slack

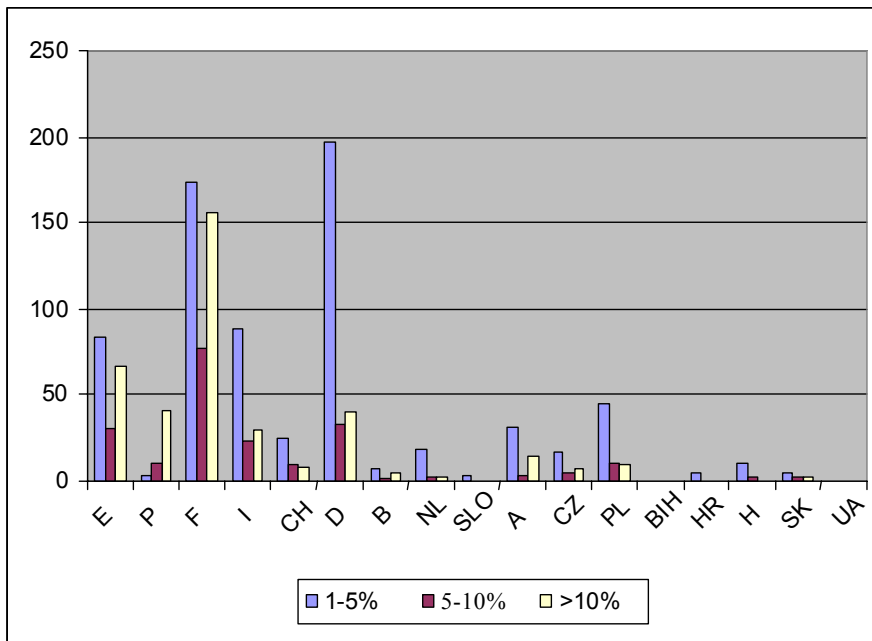

Figure 24: participations of the node 6006, which is located in Portugal, in the flows on the lines using the marginal participations method when a distributed slack bus is used

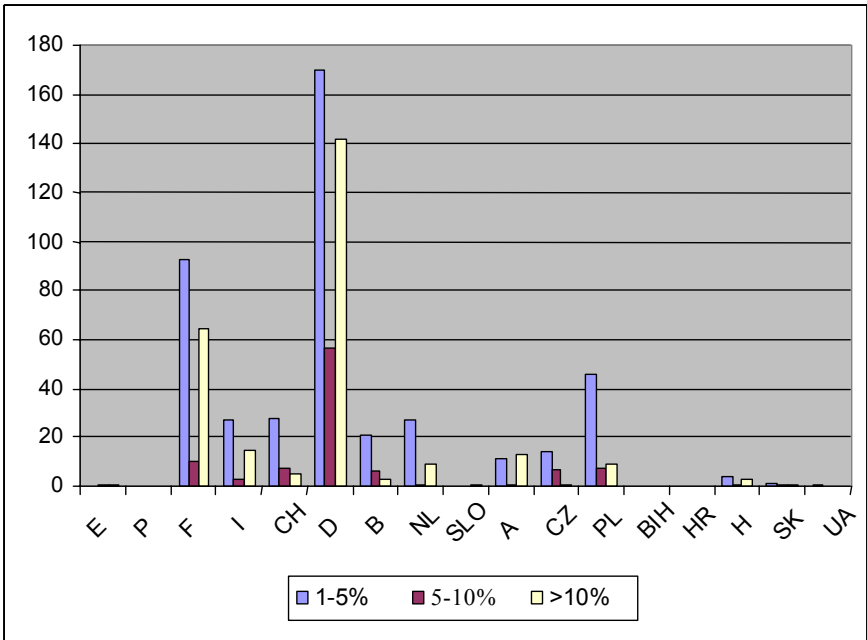

Figure 25: participations of the node 34724, which is located in Germany, in the flows on the lines using the marginal participations method when only one node is considered as the slack

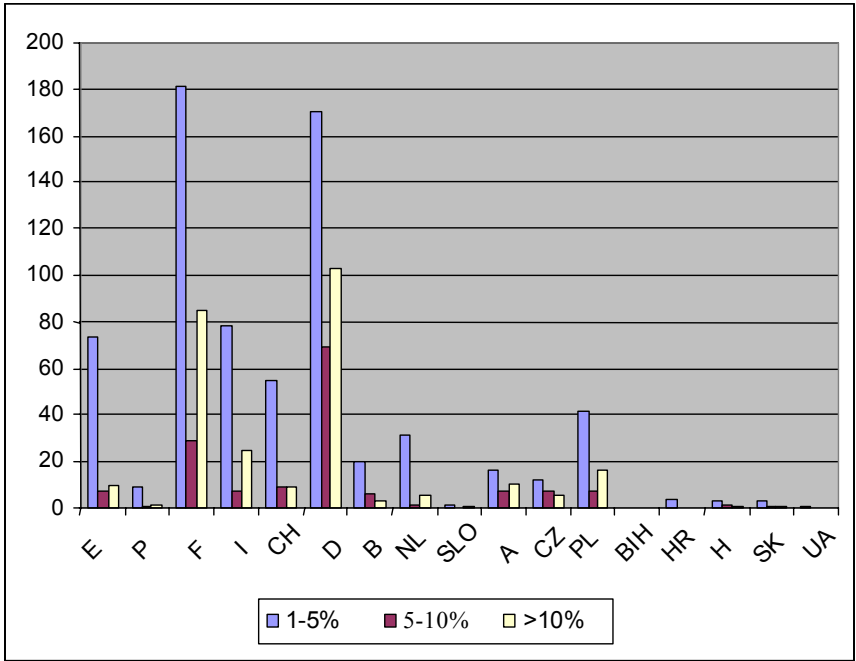

Figure 26: participations of the node 34724, which is located Germany, in the flows on the lines using the marginal participations method when a distributed slack bus is used

The analysis

The numerical results that have just been presented just confirm the properties of the MP method that were described in section 3.1.4:

- i) The results of the participation of any agent (and, consequently, of an entire country) in the total utilization of the network are very dependent of the choice of the slack or reference node.
- ii) The MP method results in participations of individual agents in a very large number of lines, many of which are located at a great distance of these agents.

The lack of direct responsiveness of the MP method to the capacity of the interconnections and the volume of energy transfers is another undesirable feature of the MP method.

As indicated in section 3.1.4, the aggregated nodal tariffs that result from the AP method can make much sense when considered in comparison with one another. The change in the reference node just adds a constant amount (which could be positive or negative) to all the G tariffs and subtracts the same amount from all the L tariffs. Despite this interesting property, it seems that the negative considerations that have just been expressed undermine the confidence in making use of the MP method.

Other results

The MP method allows the computation of nodal transmission tariffs and it can also be applied to determine the allocation of usage of a new transmission investment. Therefore, all the results that can be obtained with the AP method could be reproduced with the MP method. This would take much effort and has not been done, since the MP method has not been considered to be a valid contender, because of the reasons that have been presented above.

Computer implementation notes

No program has been developed to obtain the participations of every agent in the IEM network with the MP method. For the case examples that have been presented above, an 'IPLAN' program generates the participations of the power that is injected to or withdrawn from the node in all the lines of the system, when a specific slack node is chosen. Two different slack nodes have been considered when computing these participations. The first one is a distributed slack node and the second one is the node in Frankfurt.

Family 2: Algorithms that are based on the impact of transit flows on each considered country

5.2.5 Algorithm 5: With and without transits (WWT)

The results for compensations and charges

Table 10 presents the results of compensations and charges that are obtained with the WWT method. The meaning of all the numbers in the table has been already explained in section 3.1.

	E	P	F	I	CH	D	B	NL	SLO	A	CZ	PL	BIH	HR	H	SK	UA		
E	10.87	0.01	0.00	0.00	0.05	-0.01	0.00	0.00	0.00	0.01	0.00	0.00	0.01	0.01	0.00	0.00	0.00	10.97	0.09
P	0.00	1.92	0.00	0.00	0.02	0.00	0.00	0.00	0.00	0.00	0.00	0.00	0.00	0.00	0.00	0.00	0.00	1.95	0.03
F	-0.03	0.07	30.13	0.00	0.45	-0.11	0.03	0.03	0.03	0.12	0.03	0.01	0.05	0.09	0.04	0.02	0.00	30.94	0.81
I	-0.01	0.02	0.00	12.02	0.14	-0.04	0.01	0.01	0.01	0.04	0.01	0.00	0.02	0.03	0.01	0.00	0.00	12.28	0.26
CH	-0.01	0.01	0.00	0.00	2.46	-0.02	0.00	0.01	0.01	0.02	0.00	0.00	0.01	0.01	0.01	0.00	0.00	2.52	0.06
D	-0.01	0.02	0.00	0.00	0.13	24.10	0.01	0.01	0.01	0.03	0.01	0.00	0.02	0.03	0.01	0.00	0.00	24.38	0.27
B	0.00	0.01	0.00	0.00	0.04	-0.01	2.20	0.00	0.00	0.01	0.00	0.00	0.00	0.01	0.00	0.00	0.00	2.27	0.07
NL	-0.01	0.02	0.00	0.00	0.11	-0.03	0.01	1.87	0.01	0.03	0.01	0.00	0.01	0.02	0.01	0.01	0.00	2.06	0.18
SLO	0.00	0.00	0.00	0.00	0.02	-0.01	0.00	0.00	0.23	0.01	0.00	0.00	0.00	0.00	0.00	0.00	0.00	0.27	0.04
A	-0.01	0.01	0.00	0.00	0.09	-0.02	0.01	0.01	0.01	1.26	0.01	0.00	0.01	0.02	0.01	0.00	0.00	1.40	0.14
CZ	-0.01	0.01	0.00	0.00	0.09	-0.02	0.01	0.01	0.01	0.02	1.41	0.00	0.01	0.02	0.01	0.00	0.00	1.56	0.16
PL	0.00	0.01	0.00	0.00	0.04	-0.01	0.00	0.00	0.00	0.01	0.00	6.70	0.00	0.01	0.00	0.00	0.00	6.77	0.07
BIH	0.00	0.00	0.00	0.00	0.00	0.00	0.00	0.00	0.00	0.00	0.00	0.00	0.13	0.00	0.00	0.00	0.00	0.14	0.01
HR	0.00	0.00	0.00	0.00	0.02	-0.01	0.00	0.00	0.00	0.01	0.00	0.00	0.00	0.19	0.00	0.00	0.00	0.22	0.03
H	0.00	0.00	0.00	0.00	0.02	0.00	0.00	0.00	0.00	0.01	0.00	0.00	0.00	0.00	1.01	0.00	0.00	1.05	0.03
SK	0.00	0.00	0.00	0.00	0.01	0.00	0.00	0.00	0.00	0.00	0.00	0.00	0.00	0.00	0.00	0.00	1.13	1.16	0.03
UA	0.00	0.00	0.00	0.00	0.01	0.00	0.00	0.00	0.00	0.00	0.00	0.00	0.00	0.00	0.00	0.00	0.05	0.07	0.02
	10.78	2.12	30.13	12.02	3.71	23.81	2.28	1.96	0.33	1.58	1.48	6.72	0.29	0.44	1.13	1.18	0.05		
	10.97	1.95	30.94	12.28	2.52	24.38	2.27	2.06	0.27	1.40	1.56	6.77	0.14	0.22	1.05	1.16	0.07		
	-0.19	0.17	-0.81	-0.26	1.19	-0.57	0.01	-0.10	0.06	0.19	-0.08	-0.05	0.15	0.22	0.09	0.02	-0.02		
	-0.09	0.20	0.00	0.00	1.25	-0.30	0.08	0.09	0.10	0.32	0.07	0.02	0.16	0.25	0.12	0.05	0.00		
	0.09	0.03	0.81	0.26	0.06	0.27	0.07	0.18	0.04	0.14	0.16	0.07	0.01	0.03	0.03	0.03	0.02		

Table 10: Compensations and charges with the WWT method

The analysis

The general properties of the WWT method have been already presented in section 3.1.5, but they will be briefly summarized here:

- i) There are potential difficulties in the outcome of the artificial “without transit” operating condition.
- ii) The method itself only computes the compensations that are due to each country. An additional ad hoc method is needed to determine the charges.

When comparing the results of the AP and WWT methods in Table 4 and Table 10, it is quite obvious that, despite some broad coincidences (e.g. France pays much and Switzerland has the largest net positive inter-TSO payment), there are major differences between the results of both methods. For instance in AP Germany is a large net receiver while in WWT Germany is a large net payer. Several other major divergences exist. There are reasons for the discrepancies, since both methods have significant differences.

Note, first of all, that the underlying philosophies are quite different. The AP method only considers “positive” average use. Since AP is not an incremental method, there is in it no such a thing as “negative use”. Then, the network of a purely “non-transited” country, such as Italy, is significantly used by other countries in the AP method, while in the WWT method is not. Since the WWT method is based on transits, if there is no transit there is no compensation. Besides, the effect of a transit on a network may increase or decrease network use. This is why so many negative numbers appear in Table 10. Table 10 tells us that 5 out of 17 countries should receive either negative or no compensations at all (for the single scenario being considered). Because of all these reasons it makes no sense to compare the results of the AP and WWT methods just for the compensations. Only the comparisons of the final net inter-TSO payments can be reasonable made. And, as indicated before, they are quite different.

There are more reasons for discrepancy. The procedures of the WWT method, as well as its results, are very dependent on political borders between countries, or boundaries between TSOs. Besides, the scheme for the allocation of charges that has been adopted to complete the specification of the WWT method ignores the topology of the IEM system and spreads the charges of any country j over most of the IEM⁵¹. This can be easily observed in Table 10.

Other results

The WWT method has been designed for the specific purpose of determining compensations due to countries because of external network usage. It is not meant, and apparently cannot be used, to compute nodal tariffs or to allocate the costs of a new investment.

Computer implementation notes

In order to apply the WWT method it is necessary to run a load flow model, —such as IPLAN—, for the “without transit” operating condition for each one of the countries individually. Each country must be isolated from the rest of the system, then the transit through the country is removed from the flows at its borders and finally the total use made of the grid of the country is computed (the total MWxkm has been used here as the measure of network usage) and compared to the one in the base-case. The ‘MEPAM.C’ program is not used in the WWT method.

5.2.6 Algorithm 6: Average participations applied to transits (APT)

The results for compensations and charges

Table 11 presents the results of compensations and charges that are obtained with the APT method. The meaning of all the numbers in the table has been already explained in section 3.1.

⁵¹ The scheme for allocation of charges in the WWT method that was presented in section 3.1.5 has been borrowed from the actual practice in NORDEL when allocating the charges for compensations of losses. The same scheme is being also considered by NORDEL as a possible candidate in an internal scheme of allocation of network infrastructure costs.

	E	P	F	I	CH	D	B	NL	SLO	A	CZ	PL	BIH	HR	H	SK	UA			
E	10.57	0.07	0.01	0.00	0.00	0.00	0.00	0.00	0.00	0.00	0.00	0.00	0.00	0.00	0.00	0.00	0.00	0.00	10.66	0.09
P	0.10	2.04	0.00	0.00	0.00	0.00	0.00	0.00	0.00	0.00	0.00	0.00	0.00	0.00	0.00	0.00	0.00	0.00	2.13	0.10
F	0.07	0.00	30.10	0.00	0.35	0.34	0.08	0.00	0.00	0.00	0.00	0.00	0.00	0.00	0.00	0.00	0.00	0.00	30.94	0.84
I	0.00	0.00	0.01	11.98	0.48	0.01	0.00	0.00	0.02	0.02	0.00	0.00	0.00	0.09	0.01	0.00	0.00	0.00	12.62	0.64
CH	0.00	0.00	0.00	0.00	2.59	0.16	0.00	0.00	0.00	0.01	0.00	0.00	0.00	0.00	0.00	0.00	0.00	0.00	2.76	0.17
D	0.00	0.00	0.00	0.00	0.24	22.63	0.00	0.02	0.00	0.07	0.03	0.07	0.00	0.00	0.00	0.00	0.00	0.00	23.07	0.44
B	0.00	0.00	0.00	0.00	0.00	0.01	2.11	0.02	0.00	0.00	0.00	0.00	0.00	0.00	0.00	0.00	0.00	0.00	2.14	0.03
NL	0.00	0.00	0.00	0.00	0.00	0.24	0.08	1.92	0.00	0.00	0.00	0.00	0.00	0.00	0.00	0.00	0.00	0.00	2.24	0.32
SLO	0.00	0.00	0.00	0.00	0.00	0.00	0.00	0.00	0.23	0.02	0.00	0.00	0.00	0.03	0.00	0.00	0.00	0.00	0.29	0.05
A	0.00	0.00	0.00	0.00	0.07	0.14	0.00	0.00	0.04	1.42	0.01	0.00	0.00	0.00	0.02	0.01	0.00	0.00	1.71	0.30
CZ	0.00	0.00	0.00	0.00	0.00	0.20	0.00	0.00	0.00	0.08	1.36	0.01	0.00	0.00	0.00	0.06	0.00	0.00	1.72	0.36
PL	0.00	0.00	0.00	0.00	0.00	0.05	0.00	0.00	0.00	0.00	0.07	6.63	0.00	0.00	0.00	0.05	0.00	0.00	6.80	0.17
BIH	0.00	0.00	0.00	0.00	0.00	0.00	0.00	0.00	0.00	0.00	0.00	0.00	0.21	0.02	0.00	0.00	0.00	0.00	0.23	0.02
HR	0.00	0.00	0.00	0.00	0.00	0.00	0.00	0.00	0.05	0.00	0.00	0.00	0.08	0.29	0.02	0.00	0.00	0.00	0.45	0.16
H	0.00	0.00	0.00	0.00	0.00	0.00	0.00	0.00	0.01	0.01	0.00	0.00	0.00	0.01	1.03	0.07	0.01	0.00	1.14	0.10
SK	0.00	0.00	0.00	0.00	0.00	0.00	0.00	0.00	0.00	0.01	0.02	0.02	0.00	0.00	0.02	0.95	0.00	0.00	1.02	0.07
UA	0.00	0.00	0.00	0.00	0.00	0.00	0.00	0.00	0.00	0.00	0.00	0.00	0.00	0.00	0.01	0.04	0.04	0.04	0.09	0.05
	10.74	2.11	30.12	11.98	3.72	23.79	2.27	1.97	0.35	1.63	1.49	6.73	0.29	0.45	1.13	1.18	0.05			
	10.66	2.13	30.94	12.62	2.76	23.07	2.14	2.24	0.29	1.71	1.72	6.80	0.23	0.45	1.14	1.02	0.09			
	0.08	-0.02	-0.81	-0.64	0.96	0.72	0.13	-0.27	0.07	-0.09	-0.23	-0.07	0.06	0.00	-0.01	0.16	-0.04			
	0.17	0.07	0.03	0.00	1.13	1.16	0.16	0.05	0.12	0.21	0.13	0.10	0.08	0.16	0.10	0.23	0.01			
	0.09	0.10	0.84	0.64	0.17	0.44	0.03	0.32	0.05	0.30	0.36	0.17	0.02	0.16	0.10	0.07	0.05			

Table 11: Compensations and charges with the APT method

The analysis

The general properties of the APT method have been already presented in section 3.1.6, but they will be briefly summarized here:

- i) The APT method tries to improve some of the seemingly weak points in the WWT method by:
 - Avoiding to deal with the “without transit” operating condition and therefore basing all computations only on the existing record of physical flows.
 - Making use of the flow tracing capability of the AP algorithm in order to compute the charges by assigning responsibilities in the origin of the transits.
- ii) On the other hand, the APT method is unable to capture the nonlinear effects (such as flow reversals) that removing a transit may have on the original flow pattern in a given country.

Purely importing or exporting countries, —i.e., countries with no transits—, will not experience any difference in the two situations “with and without transit” and therefore the values in the corresponding columns in the table will be zero, except for their own use. This is for instance the case of Italy or France, as it can be observed in Table 11. These results differ much from the corresponding numbers in Table 4 for the AP method.

On the other hand, in purely transited countries, —such as Switzerland, Bosnia or the Slavik Republic—, all the border flows are transits and the numbers in the columns for these countries in Table 11, corresponding to the differences “with and without transit”, coincide with the numbers in Table 4 for the AP method.

The APT method tends to favor purely transited countries, while treating unfavorably purely importing or exporting countries. This is so because methods that are based on transits (WWT and APT) do not compensate at all the countries with no transits, -which are purely importing or exporting countries-, even though their networks are partly used by the external countries that export to them or that import from them. This effect is partly masked for purely importing countries in the WWT method, since in WWT 50% of the charges are directly applied to exporting countries (an arbitrary and questionable rule). This can be seen as a weak point of the APT method. It is also interesting to observe that the final results, —the inter-TSO payments—, for the APT and MAP methods are closest than any other of the methods that have been examined here. The similarity is not good for compensations and charges when taken separately, but it is much better for the net inter-TSO payments⁵².

Since the APT method has been developed in the context of this project and there is no previous experience with it, an additional case example has been run with a single scenario of the NORDEL system, also for January 17th, 2001, at 10.30 a.m. Annex 7 shows the results of this analysis, which confirm the conclusions that had already been obtained.

Other results

The APT method has been designed for the specific purpose of determining compensations due to countries because of external network usage. It is not meant to compute nodal tariffs or to allocate the costs of a new investment.

Computer implementation notes

This is the same method of average participations, when applied only to the part of the flows in the interconnectors that can be considered to be strictly a transit. Otherwise, the same AP algorithm for tracking the flows is employed here. The main procedural difference is that now different files are generated for each one of the countries in the system and only at the end of the process the participations of each country in the use of the grid of every country in the system are aggregated into the usual matrix, which reflects the volume of use of every country in every country's network, including its own network. The computational process is organized as follows:

- First an IPLAN program (which must be run with PSS) is used to generate the data files corresponding to each one of the countries in the system that the 'C' program 'MEPAM.C' needs to be run. Once again, this is used to generate input data to the model. The APT method only needs snapshots of the flows for each one of the considered scenarios.
- Then, for every country 'n' in the system, 'MEPAM.C' is run using the files corresponding to a country *j* in order to obtain the participation of every agent

⁵² We shall try to offer a plausible explanation for this fact, which should be verified in other scenarios. The MAP method is driven by the internal imbalances of the countries, while the APT method is driven by the transits in the countries. Complete border flows can be thought of as consisting of internal imbalances plus transits. Then it is not surprising that the differences between compensations and charges when computed from imbalances (MAP) should be similar to the differences between compensations and charges when computed from transits.

in the flow on the lines of the grid of country j . In order to obtain how much the grid of country j is used by every agent in the system, the external agents have been previously substituted by equivalent generators or loads placed on the border nodes of country j .

- Finally another 'C' program is run where, for every country j , the flows on the lines of the country that can be considered as part of the transit through it are identified first. Then it is determined which one of the neighboring countries is responsible for every transit flow in country j and, in the end, the participations are aggregated at country level and the participations of every other country in utilization of the network of country j are computed. The internal use is obtained as the difference between the total and the external use. The resulting participations are represented in one matrix that is analogous to the one shown in Table 11.

5.3 Compensations and charges because of network losses

The purpose of the different algorithms that will be applied to compute compensations, charges and net inter-TSO payments for network losses is similar to what has been seen in the preceding section for infrastructure costs. Now the idea is to compute how many of the MW of losses, in a given country j for the considered scenario, can be attributed to the agents internal to the country and how much to the external agents aggregated by countries. Therefore, the results will be expressed in MW of losses.

For instance, for most of the tables that will be shown next (methods AP, MAP, WWT and APT), the numbers in the column for Austria will correspond to how many MW of the network losses of Austria can be attributed to the network users of the different countries, including Austria. In the same way, the numbers in the row for Austria will indicate the joint responsibility of Austrian network users in the network losses of all countries, including Austria itself. The leftmost column contains the total charges for each one of the countries. The bottom row in the table gives the net inter-TSO payment (compensation minus charges because of losses) for each country, while the two rows above the bottom one contain the total compensations because of losses for each country (the top one, whose values are equal to the sum of all the numbers in the column above it) and the total charges (below, where the values of the leftmost column have been reproduced, in order to facilitate the comparison) for each country. The difference of these two rows yields the values for the inter-TSO payments in the bottom row.

The rationale behind each one of the methods has been already explained in section 3.2. The pros and cons of most of the methods have been already discussed in section 3.1 and in the preceding section 5.2. Thus, only the tables of results, without much further analysis, will be presented next.

The explanation of the tables for the new methods (MP and MPT) that are based on marginal loss factors is different and it will be provided at the corresponding sections.

Family 1 for loss allocation: Algorithms that are based on the network utilization of individual agents and complete actual cross-border flows

5.3.1 Algorithm 1 for loss allocation: Average participations (AP)

The results for compensations and charges

Table 12 presents the results of compensations and charges that are obtained with the AP method. The meaning of all the numbers in the table has been already explained in section 5.3. All figures in the table correspond to MW of losses for the considered scenario. Allocation of losses to each network user has been done by using the same participation factors as in the AP method. Then, the results are aggregated at country level. The structure of elements that equal zero and differ from zero in Table 12 is, by construction, identical to the structure in Table 4 for the AP method for infrastructure costs.

	E	P	F	I	CH	D	B	NL	SLO	A	CZ	PL	BIH	HR	H	SK	UA		
E	0.0	8.0	12.1	0.0	0.0	0.0	0.0	0.0	0.0	0.0	0.0	0.0	0.0	0.0	0.0	0.0	0.0	0.0	20.1
P	9.6	0.0	0.0	0.0	0.0	0.0	0.0	0.0	0.0	0.0	0.0	0.0	0.0	0.0	0.0	0.0	0.0	0.0	9.6
F	6.3	0.0	0.0	20.7	6.1	14.8	2.7	0.2	0.0	0.0	0.0	0.0	0.0	0.0	0.0	0.0	0.0	0.0	50.8
I	0.0	0.0	21.2	0.0	14.7	0.3	0.0	0.0	1.0	1.1	0.0	0.0	0.0	1.8	0.6	0.0	0.0	0.0	40.7
CH	0.0	0.0	6.2	11.0	0.0	2.0	0.0	0.0	0.7	0.0	0.0	0.0	0.0	0.0	0.0	0.0	0.0	0.0	19.9
D	0.0	0.0	4.0	0.2	2.6	0.0	0.2	12.5	0.0	6.4	2.9	1.8	0.0	0.0	0.0	0.0	0.0	0.0	30.6
B	0.0	0.0	7.8	0.0	0.0	0.7	0.0	4.8	0.0	0.0	0.0	0.0	0.0	0.0	0.0	0.0	0.0	0.0	13.3
NL	0.0	0.0	0.1	0.0	0.0	9.8	3.3	0.0	0.0	0.0	0.0	0.0	0.0	0.0	0.0	0.0	0.0	0.0	13.2
SLO	0.0	0.0	0.0	0.3	0.0	0.0	0.0	0.0	0.0	0.7	0.0	0.0	0.0	0.7	0.0	0.0	0.0	0.0	1.7
A	0.0	0.0	0.0	2.4	1.5	5.9	0.0	0.0	0.8	0.0	0.5	0.0	0.0	0.1	0.4	0.1	0.0	0.0	11.7
CZ	0.0	0.0	0.0	0.0	0.0	9.4	0.0	0.0	0.0	2.3	0.0	1.6	0.0	0.0	0.0	0.0	0.6	0.0	13.9
PL	0.0	0.0	0.0	0.0	0.0	0.8	0.0	0.0	0.0	0.0	2.3	0.0	0.0	0.0	0.0	0.6	0.0	0.0	3.7
BIH	0.0	0.0	0.0	0.0	0.0	0.0	0.0	0.0	0.0	0.0	0.0	0.0	0.0	1.0	0.0	0.0	0.0	0.0	1.0
HR	0.0	0.0	0.0	0.7	0.0	0.0	0.0	0.0	1.4	0.1	0.0	0.0	4.3	0.0	1.1	0.0	0.0	0.0	7.6
H	0.0	0.0	0.0	0.2	0.0	0.0	0.0	0.0	0.1	0.0	0.0	0.0	0.0	0.7	0.0	0.8	0.2	0.0	2.0
SK	0.0	0.0	0.0	0.0	0.0	0.0	0.0	0.0	0.0	0.2	1.1	1.0	0.0	0.0	0.6	0.0	0.0	0.0	2.9
UA	0.0	0.0	0.0	0.0	0.0	0.0	0.0	0.0	0.0	0.0	0.0	0.0	0.0	0.0	0.3	0.2	0.0	0.0	0.5
	15.9	8.0	51.4	35.5	24.9	43.7	6.2	17.5	3.3	11.5	6.8	4.4	4.3	4.3	3.0	2.3	0.2		
	20.1	9.6	50.8	40.7	19.9	30.6	13.3	13.2	1.7	11.7	13.9	3.7	1.0	7.6	2.0	2.9	0.5		
	-4.2	-1.6	0.6	-5.2	5.0	13.1	-7.1	4.3	1.6	-0.2	-7.1	0.7	3.3	-3.3	1.0	-0.6	-0.3		

Table 12: Compensations and charges for losses with the AP method

Computer implementation notes

The implementation is basically identical to the one for the AP method applied to infrastructure costs, as indicated before. Only the last step is different. Now, instead of running the program that aggregates at country level the participations in the use of individual lines, a different ‘C’ program is run that first allocates the losses on individual lines in the way that has been already explained and then

aggregates the results at country level to obtain compensations among countries because of losses. These compensations are expressed in MW of losses.

5.3.2 Algorithm 2 for loss allocation: Modified average participations (MAP)

The results for compensations and charges

Table 13 presents the results of compensations and charges that are obtained with the MAP method. The meaning of all the numbers in the table has been already explained in section 5.3. All figures in the table correspond to MW of losses for the considered scenario. Allocation of losses to each network user has been done by using the same participation factors as in the MAP method. Then, the results are aggregated at country level. The structure of elements that equal zero and differ from zero in Table 13 is, by construction, identical to the structure in Table 9 for the MAP method for infrastructure costs.

	E	P	F	I	CH	D	B	NL	SLO	A	CZ	PL	BIH	HR	H	SK	UA		
E	0.0	2.8	8.2	0.0	0.0	0.0	0.0	0.0	0.0	0.0	0.0	0.0	0.0	0.0	0.0	0.0	0.0	0.0	11.0
P	4.0	0.0	0.0	0.0	0.0	0.0	0.0	0.0	0.0	0.0	0.0	0.0	0.0	0.0	0.0	0.0	0.0	0.0	4.0
F	5.4	0.0	0.0	20.6	6.1	14.5	2.7	0.2	0.0	0.0	0.0	0.0	0.0	0.0	0.0	0.0	0.0	0.0	49.5
I	0.0	0.0	21.0	0.0	14.7	0.2	0.0	0.0	1.0	1.1	0.0	0.0	0.0	1.8	0.6	0.0	0.0	0.0	40.4
CH	0.0	0.0	0.0	0.4	0.0	0.1	0.0	0.0	0.0	0.0	0.0	0.0	0.0	0.0	0.0	0.0	0.0	0.0	0.5
D	0.0	0.0	1.0	0.0	0.1	0.0	0.0	0.0	0.0	1.4	0.7	0.0	0.0	0.0	0.0	0.0	0.0	0.0	3.2
B	0.0	0.0	3.1	0.0	0.0	0.3	0.0	0.3	0.0	0.0	0.0	0.0	0.0	0.0	0.0	0.0	0.0	0.0	3.7
NL	0.0	0.0	0.1	0.0	0.0	9.5	3.3	0.0	0.0	0.0	0.0	0.0	0.0	0.0	0.0	0.0	0.0	0.0	12.9
SLO	0.0	0.0	0.0	0.1	0.0	0.0	0.0	0.0	0.0	0.0	0.0	0.0	0.0	0.0	0.0	0.0	0.0	0.0	0.1
A	0.0	0.0	0.0	1.8	1.3	4.7	0.0	0.0	0.6	0.0	0.0	0.0	0.0	0.1	0.0	0.0	0.0	0.0	8.5
CZ	0.0	0.0	0.0	0.0	0.0	6.0	0.0	0.0	0.0	1.4	0.0	0.0	0.0	0.0	0.0	0.7	0.0	0.0	8.1
PL	0.0	0.0	0.0	0.0	0.0	0.0	0.0	0.0	0.0	0.0	1.7	0.0	0.0	0.0	0.0	0.5	0.0	0.0	2.2
BIH	0.0	0.0	0.0	0.0	0.0	0.0	0.0	0.0	0.0	0.0	0.0	0.0	0.0	0.0	0.0	0.0	0.0	0.0	0.0
HR	0.0	0.0	0.0	0.1	0.0	0.0	0.0	0.0	0.1	0.0	0.0	0.0	0.1	0.0	0.0	0.0	0.0	0.0	0.3
H	0.0	0.0	0.0	0.0	0.0	0.0	0.0	0.0	0.0	0.0	0.0	0.0	0.0	0.0	0.0	0.4	0.1	0.0	0.5
SK	0.0	0.0	0.0	0.0	0.0	0.0	0.0	0.0	0.0	0.0	0.0	0.0	0.0	0.0	0.0	0.0	0.0	0.0	0.0
UA	0.0	0.0	0.0	0.0	0.0	0.0	0.0	0.0	0.0	0.0	0.0	0.0	0.0	0.0	0.3	0.2	0.0	0.0	0.5
	9.4	2.8	33.4	23.0	22.2	35.3	6.0	0.5	1.7	3.9	2.4	0.0	0.1	1.9	0.9	1.8	0.1		
	11.0	4.0	49.5	40.4	0.5	3.2	3.7	12.9	0.1	8.5	8.1	2.2	0.0	0.3	0.5	0.0	0.5		
	-1.6	-1.2	-16.1	-17.4	21.7	32.1	2.3	-12.4	1.6	-4.6	-5.7	-2.2	0.1	1.6	0.4	1.8	-0.4		

Table 13: Compensations and charges for losses with the MAP method

Computer implementation notes

The same comments that have been made for the AP method in the preceding section apply also here.

5.3.3 Algorithm 3 for loss allocation: Marginal loss factors applied to border flows (MP)

The results for compensations and charges

Table 14 presents the results of compensations and charges that are obtained with the MP method. The numbers correspond to the description of the method in section 3.2.3. For instance, the figures in the column for Germany

indicate the amount of losses that Germany must be compensated for by the neighboring countries (and not by Germany itself; this is why all the numbers in the diagonal of the table are zero) as a result of multiplying the loss factor at the border for one interconnection times the total flow in the interconnection. Note that there are no negative numbers in the table because, for any cross border flow between 2 countries A and B, when the compensation must be paid to A the figure is included as the element of the matrix corresponding to row ‘B’ and column ‘A’ and vice versa if the compensation is due to ‘B’.

	E	P	F	I	CH	D	B	NL	SLO	A	CZ	PL	BIH	HR	H	SK	UA	
E	0.0	19.9	3.9	0.0	0.0	0.0	0.0	0.0	0.0	0.0	0.0	0.0	0.0	0.0	0.0	0.0	0.0	23.9
P	21.0	0.0	0.0	0.0	0.0	0.0	0.0	0.0	0.0	0.0	0.0	0.0	0.0	0.0	0.0	0.0	0.0	21.0
F	5.7	0.0	0.0	8.5	20.4	39.4	3.7	0.0	0.0	0.0	0.0	0.0	0.0	0.0	0.0	0.0	0.0	77.6
I	0.0	0.0	8.2	0.0	65.5	0.0	0.0	0.0	14.1	0.2	0.0	0.0	0.0	0.0	0.0	0.0	0.0	88.0
CH	0.0	0.0	3.7	1.5	0.0	6.4	0.0	0.0	0.0	5.5	0.0	0.0	0.0	0.0	0.0	0.0	0.0	17.1
D	0.0	0.0	2.6	0.0	5.9	0.0	0.0	1.8	0.0	7.9	0.0	6.0	0.0	0.0	0.0	0.0	0.0	24.3
B	0.0	0.0	10.5	0.0	0.0	0.0	0.0	7.2	0.0	0.0	0.0	0.0	0.0	0.0	0.0	0.0	0.0	17.8
NL	0.0	0.0	0.0	0.0	0.0	28.2	17.9	0.0	0.0	0.0	0.0	0.0	0.0	0.0	0.0	0.0	0.0	46.1
SLO	0.0	0.0	0.0	0.0	0.0	0.0	0.0	0.0	0.0	2.5	0.0	0.0	0.0	11.4	0.0	0.0	0.0	13.9
A	0.0	0.0	0.0	0.0	0.0	0.5	0.0	0.0	0.0	0.0	0.0	0.0	0.0	0.0	0.1	0.0	0.0	0.5
CZ	0.0	0.0	0.0	0.0	0.0	22.6	0.0	0.0	0.0	11.9	0.0	0.0	0.0	0.0	0.0	7.9	0.0	42.4
PL	0.0	0.0	0.0	0.0	0.0	0.0	0.0	0.0	0.0	0.0	25.3	0.0	0.0	0.0	0.0	0.7	0.0	26.0
BIH	0.0	0.0	0.0	0.0	0.0	0.0	0.0	0.0	0.0	0.0	0.0	0.0	0.0	0.4	0.0	0.0	0.0	0.4
HR	0.0	0.0	0.0	0.0	0.0	0.0	0.0	0.0	2.9	0.0	0.0	0.0	14.5	0.0	0.0	0.0	0.0	17.4
H	0.0	0.0	0.0	0.0	0.0	0.0	0.0	0.0	0.0	2.2	0.0	0.0	0.0	1.2	0.0	0.0	0.9	4.3
SK	0.0	0.0	0.0	0.0	0.0	0.0	0.0	0.0	0.0	0.0	0.2	0.0	0.0	0.0	12.1	0.0	0.0	12.3
UA	0.0	0.0	0.0	0.0	0.0	0.0	0.0	0.0	0.0	0.0	0.0	0.0	0.0	0.0	2.3	1.8	0.0	4.1
	26.7	19.9	28.9	10.0	91.8	97.0	21.6	9.1	17.0	30.2	25.5	6.0	14.5	13.0	14.4	10.4	0.9	
	23.9	21.0	77.6	88.0	17.1	24.3	17.8	46.1	13.9	0.5	42.4	26.0	0.4	17.4	4.3	12.3	4.1	
	2.8	-1.0	-48.7	-78.0	74.7	72.7	3.8	-37.0	3.1	29.7	-17.0	-20.0	14.1	-4.4	10.1	-1.9	-3.2	

Table 14: Compensations and charges for losses with the MP method

Similarly, the numbers in the row for Germany are the charges that Germany has to pay (or receive, if the number is negative) to its neighboring countries. The remaining column and rows in the table have the same meaning that the other tables for losses.

Computer implementation notes

The method of marginal loss factors has been applied under two different formats:

To the total flows in the interconnectors at the borders between countries (MP method).

To that part of the flows in the interconnectors at the borders between countries that correspond to the transit for each country that is being considered (MPT method, whose results will be presented later).

Two ‘IPLAN’ programs have been developed, one to compute the compensations between countries in the first case (MP) and the other one when only the flows that are part of the transit are considered (MPT). The results of the MP method

strongly depend on the choice of the slack node. Here a distributed slack has been considered, such that all the loads in the system respond in pro rata to 50% of the variation in the power injected or withdrawn from the system and all the generators respond also in pro rata to the remaining 50%.

Family 2 for loss allocation: Algorithms that are based on the impact of transit flows on each considered country

5.3.4 Algorithm 4 for loss allocation: With and without transits (WWT)

The results for compensations and charges

Table 15 presents the results of compensations and charges that are obtained with the WWT method. The meaning of all the numbers in the table has been already explained in section 5.3. All figures in the table correspond to MW of losses for the considered scenario.

	E	P	F	I	CH	D	B	NL	SLO	A	CZ	PL	BIH	HR	H	SK	UA	
E	0.0	0.2	-0.9	0.0	0.6	-1.6	0.0	0.1	-0.1	0.3	-0.2	-0.1	0.3	-2.7	0.0	-0.3	0.0	-4.4
P	-0.3	0.0	-0.3	0.0	0.2	-0.6	0.0	0.0	0.0	0.1	-0.1	0.0	0.1	-1.0	0.0	-0.1	0.0	-2.0
F	-7.2	1.7	0.0	0.0	5.4	-14.5	-0.4	0.8	-1.0	2.9	-1.5	-1.2	2.7	-23.9	0.3	-2.9	0.0	-38.6
I	-2.3	0.5	-2.6	0.0	1.7	-4.6	-0.1	0.3	-0.3	0.9	-0.5	-0.4	0.9	-7.6	0.1	-0.9	0.0	-14.8
CH	-1.2	0.3	-1.3	0.0	0.0	-2.3	-0.1	0.1	-0.2	0.5	-0.2	-0.2	0.4	-3.9	0.1	-0.5	0.0	-8.4
D	-2.1	0.5	-2.4	0.0	1.6	0.0	-0.1	0.2	-0.3	0.9	-0.4	-0.3	0.8	-7.1	0.1	-0.9	0.0	-9.6
B	-0.7	0.2	-0.8	0.0	0.5	-1.3	0.0	0.1	-0.1	0.3	-0.1	-0.1	0.3	-2.2	0.0	-0.3	0.0	-4.3
NL	-1.7	0.4	-1.9	0.0	1.3	-3.4	-0.1	0.0	-0.2	0.7	-0.4	-0.3	0.6	-5.7	0.1	-0.7	0.0	-11.3
SLO	-0.4	0.1	-0.4	0.0	0.3	-0.7	0.0	0.0	0.0	0.1	-0.1	-0.1	0.1	-1.2	0.0	-0.1	0.0	-2.3
A	-1.4	0.3	-1.6	0.0	1.1	-2.9	-0.1	0.2	-0.2	0.0	-0.3	-0.2	0.5	-4.7	0.1	-0.6	0.0	-9.9
CZ	-1.5	0.3	-1.7	0.0	1.1	-2.9	-0.1	0.2	-0.2	0.6	0.0	-0.2	0.6	-4.8	0.1	-0.6	0.0	-9.2
PL	-0.6	0.1	-0.7	0.0	0.5	-1.2	0.0	0.1	-0.1	0.2	-0.1	0.0	0.2	-2.1	0.0	-0.3	0.0	-3.9
BIH	-0.1	0.0	-0.1	0.0	0.0	-0.1	0.0	0.0	0.0	0.0	0.0	0.0	0.0	-0.2	0.0	0.0	0.0	-0.4
HR	-0.3	0.1	-0.4	0.0	0.2	-0.7	0.0	0.0	0.0	0.1	-0.1	-0.1	0.1	0.0	0.0	-0.1	0.0	-1.0
H	-0.3	0.1	-0.4	0.0	0.2	-0.6	0.0	0.0	0.0	0.1	-0.1	-0.1	0.1	-1.0	0.0	-0.1	0.0	-2.0
SK	-0.2	0.1	-0.3	0.0	0.2	-0.5	0.0	0.0	0.0	0.1	-0.1	0.0	0.1	-0.8	0.0	0.0	0.0	-1.5
UA	-0.2	0.1	-0.2	0.0	0.2	-0.4	0.0	0.0	0.0	0.1	0.0	0.0	0.1	-0.7	0.0	-0.1	0.0	-1.4
	-20.4	5.0	-16.0	0.0	15.1	-38.5	-1.1	2.3	-2.8	7.9	-4.1	-3.3	8.0	-69.6	1.0	-8.6	0.0	
	-4.4	-2.0	-38.6	-14.8	-8.4	-9.6	-4.3	-11.3	-2.3	-9.9	-9.2	-3.9	-0.4	-1.0	-2.0	-1.5	-1.4	
	-16.0	7.0	22.6	14.8	23.6	-28.9	3.2	13.6	-0.5	17.8	5.0	0.6	8.5	-68.5	3.0	-7.1	1.4	

Table 15: Compensations and charges for losses with the WWT method

Computer implementation notes

By means of an 'IPLAN' program, the fraction of the losses in each country that must be attributed to the transit through it are calculated. As it has been explained above, the algorithm first computes the losses in the country considering the actual flows, then it computes again the losses when the flow at each border node is decreased by the amount that has been established to correspond to the transit. The losses due to the transit are obtained as the difference between the value for them in the former and the later case. The aforementioned 'IPLAN' program computes the net compensation to be paid to each country, then it distributes this compensation among the countries. Table 15 shows the matrix of compensations among countries. The economic compensations due to all countries are obtained

from a fund that all the countries have contributed to create. The amount of money each of the countries provides to this fund is based on its aggregated export flow on the one hand and on its internal imbalance between generation and demand on the other. The algorithm that is used to allocate the amount of losses that any country j must be compensated for has been slightly modified so that country j never pays part of its own losses.

5.3.5 Algorithm 5 for loss allocation: Average participations applied to transits (APT)

The results for compensations and charges

Table 16 presents the results of compensations and charges that are obtained with the APT method. The meaning of all the numbers in the table has been already explained in section 5.3.

	E	P	F	I	CH	D	B	NL	SLO	A	CZ	PL	BIH	HR	H	SK	UA	
E	0.0	6.0	0.7	0.0	0.0	0.0	0.0	0.0	0.0	0.0	0.0	0.0	0.0	0.0	0.0	0.0	0.0	6.7
P	4.4	0.0	0.0	0.0	0.0	0.0	0.0	0.0	0.0	0.0	0.0	0.0	0.0	0.0	0.0	0.0	0.0	4.4
F	2.5	0.0	0.0	0.0	6.7	11.4	1.6	0.0	0.0	0.0	0.0	0.0	0.0	0.0	0.0	0.0	0.0	22.2
I	0.0	0.0	0.5	0.0	14.3	0.2	0.0	0.0	0.9	0.3	0.0	0.0	0.0	1.7	0.6	0.0	0.0	18.5
CH	0.0	0.0	0.2	0.0	0.0	1.8	0.0	0.0	0.0	0.2	0.0	0.0	0.0	0.0	0.0	0.0	0.0	2.2
D	0.0	0.0	0.1	0.0	2.6	0.0	0.1	1.1	0.0	1.9	1.1	1.8	0.0	0.0	0.0	0.0	0.0	8.7
B	0.0	0.0	0.2	0.0	0.0	0.7	0.0	1.1	0.0	0.0	0.0	0.0	0.0	0.0	0.0	0.0	0.0	2.0
NL	0.0	0.0	0.0	0.0	0.0	10.0	3.3	0.0	0.0	0.0	0.0	0.0	0.0	0.0	0.0	0.0	0.0	13.3
SLO	0.0	0.0	0.0	0.0	0.0	0.0	0.0	0.0	0.0	0.2	0.0	0.0	0.0	0.8	0.0	0.0	0.0	1.0
A	0.0	0.0	0.0	0.0	1.5	4.7	0.0	0.0	0.8	0.0	0.2	0.0	0.0	0.1	0.4	0.1	0.0	7.8
CZ	0.0	0.0	0.0	0.0	0.0	7.4	0.0	0.0	0.0	2.3	0.0	0.4	0.0	0.0	0.0	0.6	0.0	10.7
PL	0.0	0.0	0.0	0.0	0.0	0.8	0.0	0.0	0.0	0.0	2.3	0.0	0.0	0.0	0.0	0.7	0.0	3.8
BIH	0.0	0.0	0.0	0.0	0.0	0.0	0.0	0.0	0.0	0.0	0.0	0.0	0.0	1.0	0.0	0.0	0.0	1.0
HR	0.0	0.0	0.0	0.0	0.0	0.0	0.0	0.0	1.4	0.0	0.0	0.0	4.3	0.0	1.1	0.0	0.0	6.8
H	0.0	0.0	0.0	0.0	0.0	0.0	0.0	0.0	0.1	0.0	0.0	0.0	0.0	0.7	0.0	0.8	0.1	1.7
SK	0.0	0.0	0.0	0.0	0.0	0.0	0.0	0.0	0.0	0.2	0.4	0.3	0.0	0.0	0.3	0.0	0.0	1.2
UA	0.0	0.0	0.0	0.0	0.0	0.0	0.0	0.0	0.0	0.0	0.0	0.0	0.0	0.0	0.1	0.2	0.0	0.3
	6.9	6.0	1.7	0.0	25.1	37.0	5.0	2.2	3.2	5.1	4.0	2.5	4.3	4.3	2.5	2.4	0.1	
	6.7	4.4	22.2	18.5	2.2	8.7	2.0	13.3	1.0	7.8	10.7	3.8	1.0	6.8	1.7	1.2	0.3	
	0.2	1.6	-20.5	-18.5	22.9	28.3	3.0	-11.1	2.2	-2.7	-6.7	-1.3	3.3	-2.5	0.8	1.2	-0.2	

Table 16: Compensations and charges for losses with the APT method

Computer implementation notes

Like the rest of the methods that are based on the application of the AP algorithm, when the compensations among countries for losses are to be computed with APT, the same method is applied as when it is the network infrastructure that is being allocated. Only after having computed the participations of each one of the remaining countries in the use of every line within some country j , there is a variation in the process with respect to the one followed to allocate network utilization. The losses of each line are again distributed proportionally to the flows in the line whose responsibility has been already assigned. Finally, the participations in the losses on individual lines are aggregated at country level to obtain compensations for losses among countries.

5.3.6 Algorithm 6 for loss allocation: Marginal loss factors applied to transits (MPT)

The results for compensations and charges

Table 17 presents the results of compensations and charges that are obtained with the MPT method. The meaning of all the numbers in the table differs from the one provided in section 5.3.3 for the MP method. The reason is that each country has its own transits, which do not correspond in value to the transits of neighboring countries at the common borders. Now the column in the table for a country j represents how much each one of the remaining countries must pay (if the number is positive) or receive (if it is negative) because of the application of the corresponding marginal loss factor to the transit flow at the border with each one of the neighboring countries of country j .

	E	P	F	I	CH	D	B	NL	SLO	A	CZ	PL	BIH	HR	H	SK	UA		
E	0.0	2.9	-3.3	0.0	0.0	0.0	0.0	0.0	0.0	0.0	0.0	0.0	0.0	0.0	0.0	0.0	0.0	-0.4	
P	-13.0	0.0	0.0	0.0	0.0	0.0	0.0	0.0	0.0	0.0	0.0	0.0	0.0	0.0	0.0	0.0	0.0	0.0	-13.0
F	-4.7	0.0	0.0	0.0	6.6	15.3	-2.8	0.0	0.0	0.0	0.0	0.0	0.0	0.0	0.0	0.0	0.0	0.0	14.4
I	0.0	0.0	-0.4	0.0	25.3	0.0	0.0	0.0	1.4	-0.6	0.0	0.0	0.0	0.0	0.0	0.0	0.0	0.0	25.7
CH	0.0	0.0	-0.1	0.0	0.0	1.1	0.0	0.0	0.0	0.3	0.0	0.0	0.0	0.0	0.0	0.0	0.0	0.0	1.4
D	0.0	0.0	-0.7	0.0	0.6	0.0	0.0	-1.0	0.0	-0.2	-2.3	0.8	0.0	0.0	0.0	0.0	0.0	0.0	-2.7
B	0.0	0.0	0.3	0.0	0.0	0.0	0.0	1.4	0.0	0.0	0.0	0.0	0.0	0.0	0.0	0.0	0.0	0.0	1.7
NL	0.0	0.0	0.0	0.0	0.0	6.9	1.4	0.0	0.0	0.0	0.0	0.0	0.0	0.0	0.0	0.0	0.0	0.0	8.3
SLO	0.0	0.0	0.0	0.0	0.0	0.0	0.0	0.0	0.0	0.1	0.0	0.0	0.0	0.7	0.0	0.0	0.0	0.0	0.9
A	0.0	0.0	0.0	0.0	-0.9	-4.3	0.0	0.0	0.6	0.0	-1.2	0.0	0.0	0.0	0.0	0.0	0.0	0.0	-5.9
CZ	0.0	0.0	0.0	0.0	0.0	8.1	0.0	0.0	0.0	5.5	0.0	-3.3	0.0	0.0	0.0	0.0	-1.1	0.0	9.2
PL	0.0	0.0	0.0	0.0	0.0	-3.9	0.0	0.0	0.0	0.0	3.2	0.0	0.0	0.0	0.0	0.0	-0.4	0.0	-1.0
BIH	0.0	0.0	0.0	0.0	0.0	0.0	0.0	0.0	0.0	0.0	0.0	0.0	0.0	-10.0	0.0	0.0	0.0	0.0	-10.0
HR	0.0	0.0	0.0	0.0	0.0	0.0	0.0	0.0	-4.7	0.0	0.0	0.0	7.9	0.0	0.3	0.0	0.0	0.0	3.6
H	0.0	0.0	0.0	0.0	0.0	0.0	0.0	0.0	0.0	0.7	0.0	0.0	0.0	-0.5	0.0	-1.0	-2.6	0.0	-3.5
SK	0.0	0.0	0.0	0.0	0.0	0.0	0.0	0.0	0.0	0.0	-0.5	0.1	0.0	0.0	0.4	0.0	0.0	2.6	2.6
UA	0.0	0.0	0.0	0.0	0.0	0.0	0.0	0.0	0.0	0.0	0.0	0.0	0.0	0.0	-0.4	-0.6	0.0	0.0	-1.0
	-17.8	2.9	-4.1	0.0	31.6	23.3	-1.5	0.4	-2.7	5.8	-0.8	-2.4	7.9	-9.7	0.3	-3.1	0.0	0.0	0.0
	-0.4	-13.0	14.4	25.7	1.4	-2.7	1.7	8.3	0.9	-5.9	9.2	-1.0	-10.0	3.6	-3.5	2.6	-1.0	0.0	0.0
	-17.4	15.9	-18.5	-25.7	30.2	26.0	-3.1	-7.9	-3.6	11.7	-10.0	-1.4	17.9	-13.3	3.8	-5.7	1.0	0.0	0.0

Table 17: Compensations and charges for losses with the MPT method

Computer implementation notes

In the MPT method the marginal loss factors, which are computed at every border node of the system, are only applied to the fraction of the flows at the border nodes that is part of the transit through the considered country. As it has been already mentioned, an IPLAN program has been developed that computes the compensations among countries from the PSS format file describing the scenario. Note that, for a given interconnection line between countries j and k , the transit flow that is part of the transit through country j is in general not the same as the transit flow that is part of the transit through country k . Thus the compensation country A must pay to country B because of the losses incurred by the transit does not need to be of the same amount and opposite sign as the one that country B must pay to country A .

Both a distributed slack node and only one node as the slack have been used and it has been checked that, —as the theory rightly predicts—, the compensation due to

a country because of its transit is the same independently of the slack bus that has been considered. The same property does not apply when the net compensation to all border flows (and not only to the transits) in a country is being computed. However, even in the MPT method, *inter-TSO payments* do depend on the considered slack bus, although the *compensation* due to each country because of the transit does not. Therefore, the property of slack independence does not apply when computing net payments, —only for compensations—, even if only the transits, —and not the actual flows—, are considered.

5.4 Information on the use of locational signals

It is important to understand the role that the inter-TSO payment mechanism that has been adopted in the Florence Forum has with respect to sending correct locational signals. First one has to acknowledge that inter-TSO payments are primarily meant to compensate economically those countries whose networks are being used by external users and not as a means to send precise locational signals to the individual agents of the market, even though inter-TSO payments in the end will result in a correction to the local G and L charges. This means that other mechanisms are needed in this respect.

Then, we have to recall the role that, according to the accepted conclusions of the Florence process, corresponds to long-term and short-term signals. In Florence it has been accepted an almost complete separation of the economic signals for operation and network costs recovery:

- *Operation*: Short-term locational signals are intended to maintain the efficiency in the dispatch of generation and load in the IEM. These signals must internalize the effect of congestions and losses in the network. Therefore adequate congestion management procedures must be adopted with the purpose of achieving maximum efficiency in the utilization of the limited network capacities. Much progress has been already achieved in this respect. The resulting locational signals will be strong if systematic congestions take place in the system. Any revenues (congestion rents) that might be obtained from the application of the short-term signals should be deducted from the total network costs that need to be recovered (see the next bullet).

The procedure to deal with losses is far less advanced since losses do not have security implications and an IEM-wide scheme of computation of loss factors for operation purposes still appears to have significant practical difficulties. So far it has been agreed that the extra cost of losses that a country incurs because of cross-border transits must be compensated and it will be a component of the inter-TSO payments.

- *Network cost recovery*: Longer-term (typically annual) charges are used to pay for the regulated transmission network cost. Since any locational signal that might be intended with these charges has a long-term nature, these charges must not be transaction-based, since transactions typically vary much with time and only the position of each agent in the network remains. National transmission tariffs, —the domestic G and L charges, which could include locational signals at national level—, serve this purpose. Inter-TSO payments

introduce some adjustments into the mechanisms for network cost recovery at national level.

Let us now examine the potential impact of the inter-TSO payments as provider of additional locational signals. As indicated in section 5.2.1 (see section 5.4.1 below for a more detailed explanation), a method such as AP starts by computing the EU-wide long-term *nodal charges* that fully recover the total standardized transmission network costs in the IEM system. This is therefore a totally feasible task, under a technical viewpoint. However, instead of using this information directly, the inter-TSO payments scheme aggregates the charges for all nodes of a given country j and compares that result with the country's standardized total transmission cost, in order to determine the net inter-TSO payment for country j . Then, this amount has to be allocated internally to the agents within the country. Depending on how all these processes are performed, the initial correct nodal long-term locational signals may be partly lost. In most cases, at least the geographical differentiation within the country will disappear, once the charge has been aggregated at country level. From a wider inter-country perspective, the issue is the relevance of the corrections that result from the inter-TSO payments when compared to the existing differences between the regulated transmission tariffs in the different countries⁵³.

The next two subsections expand on these issues and present some results on the potential of the mechanism of inter-TSO payments as provider of locational signals.

5.4.1 Nodal transmission network tariffs

The proposed set of computer tools and methods that have been made available in the present study are able to allocate the cost of the complete transmission network of the IEM to the individual agents that are located at each one of the 3,383 nodes in the system, in order to obtain a set of nodal transmission tariffs that takes the concept of locational signals to its ultimate consequences.

This result may not be useful in a first phase of the implementation of the Internal Electricity Market, if there is no willingness to go as far in the tariff harmonization process as to apply locational signals at this level of thoroughness. This may be also a reasonable decision, given the present lack of harmonization in very basic issues of transmission tariffication, such as the determination of regulated network remuneration and tariff design, as discussed in section 2.1.1. However, the results in this section may provide useful hints on the extent of the simplifications that are introduced in any proposal for the long-term approach and they may also guide the efforts for improvements on the provisional and the long-term approaches.

The procedures to compute a full set of nodal transmission tariffs for the complete IEM network are already available. This result is a byproduct of some of the methods that have been programmed: the so called first family of algorithms, which are based on the network utilization of individual agents and complete

⁵³ See section 2.1.1 for detailed information on this issue.

actual cross-border flows. The only real difficulty is to obtain the data for a representative number of scenarios, so that the numbers that are obtained have real meaning. Another practical difficulty is to find a clear and convenient way of presenting the results for so many nodes over the geography of the IEM.

As a sample of what could be achieved if a representative number of scenarios were available, Figure 27 shows the values of the nodal tariffs for consumers that result from application of the AP method to the 3,383 nodes in the UCTE model. The histogram indicates that there is a small number of outliers among the consumer nodes who have transmission tariffs much higher than the average. Figure 28 provides a meaningful explanation: the outliers are nodes with very low values of demand. If these nodes are connected by a dedicated line to the main grid, the cost of the line (very short, typically, but the model assumes all lines have equal length) will be fully assigned to a low demand, resulting in very high tariffs.

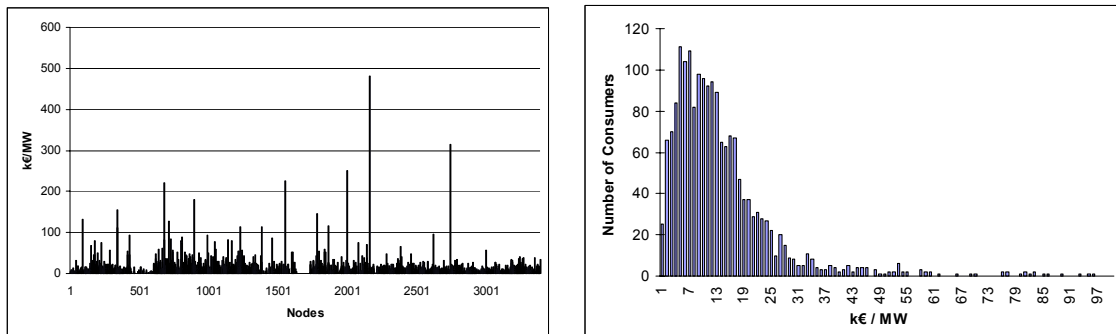

Figure 27: Transmission tariffs for consumers

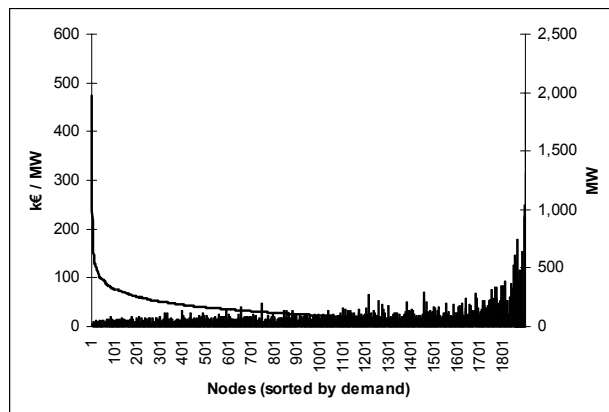

Figure 28: Sorted consumer nodes by demand

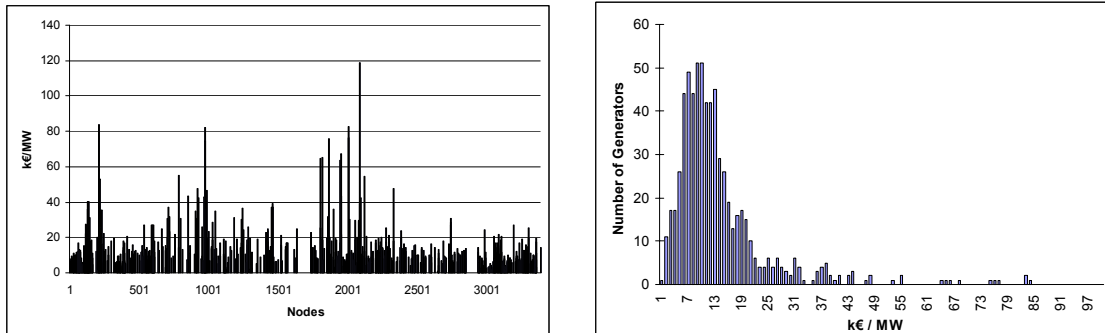

Figure 29: Transmission tariffs for generators

Similar considerations apply to the nodal transmission tariffs for generators, see Figure 29.

Table 18 and Figure 30 provide the average nodal tariffs per country that are obtained by averaging the nodal tariffs over the consumers first (i.e. assuming that only consumers are charged) and then over the generators. Note that, for the 9 UCTE countries that belong to the IEM, the values of the tariffs obtained from the AP method and standardized network costs range from less than a ratio of 2 to 1, while the actual tariffs in these countries have a much wider range⁵⁴.

Note that a low average nodal tariff in a country does not necessarily imply that the country must receive a large compensation, and conversely, since other factors are also at play. For instance, in the considered scenario Switzerland must receive a large compensation, -see section 5.2.1-, but it also has a large average nodal tariff, as shown in Table 18 and Figure 30. The reason appears to be the high density of transmission assets per unit of generation or load in Switzerland. Despite the high external usage of the Swiss network, the Swiss agents also have a large utilization of network assets within their country and abroad. The net inter-TSO payments are favorable for Switzerland, but the Swiss transmission tariff is still high.

All kinds of results can be obtained once the nodal pan-European transmission tariffs are available. However, once again, it must be remembered that the numerical values in these tables correspond to just one scenario and they cannot be considered to be representative of what the actual values could be.

⁵⁴ See [Pérez-Arriaga et al., 2001].

Country	Average L	Average G
E	9,601	9,008
P	8,008	8,367
F	10,887	10,866
I	10,303	9,066
CH	12,420	13,074
D	9,981	9,473
B	8,188	7,131
NL	6,060	4,492
SLO	10,001	5,508
A	10,447	12,124
CZ	3,811	5,649
PL	9,318	8,591
BIH	14,479	12,010
HR	8,139	12,445
H	7,095	6,495
SK	9,327	7,947
UA	34,106	14,256

Table 18: Average transmission tariffs per country (€ / MW)

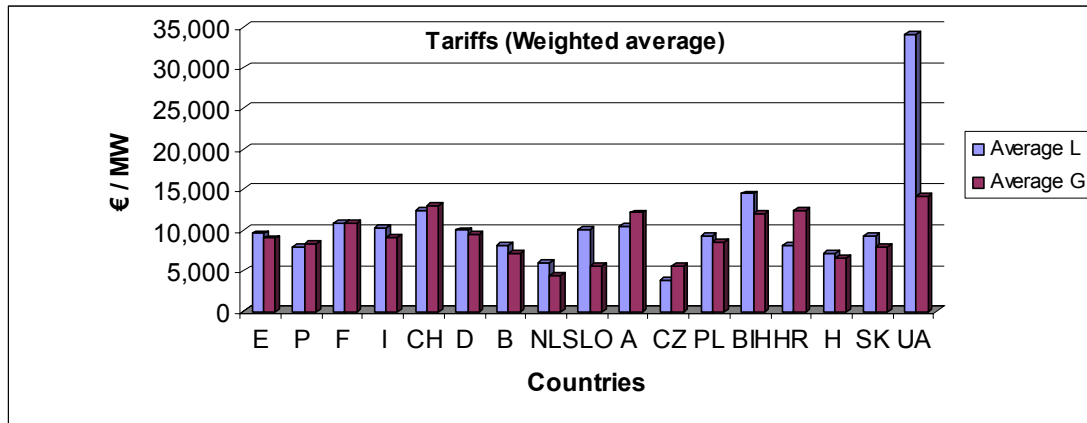

Figure 30: Average transmission tariffs per country.

5.4.2 Loss factors in the IEM

Pan-European loss factors can be also obtained as a byproduct of some of the algorithms that have been examined in this study.

- By using the same technique than in the method of marginal participations (MP), it is possible to compute, one node at a time⁵⁵, the marginal impact on the total system losses of an extra injection to or retrieval from the network at each node. However, a reference node is needed when making these computations and the results will depend on this choice, as it is usual in the MP method.

⁵⁵ More accurate methods are possible if the Jacobian matrix of the network flow model is available for manipulation.

Pan-European average loss factors can be obtained as a by-product of the method of average participations (AP), since the losses at each line are assigned to the individual nodes of demand and generation.

5.5 Impact of new interconnections and increased commercial flows

When real flow network models are used, any new network reinforcement can be incorporated into the model and the algorithms take care of the new transmission facility automatically. There is no distinction in the treatment of existing and new network elements. As new reinforcements appear and different commercial flow patterns evolve, the algorithms will take care of them automatically.

This is particularly true for the family of algorithms that are based on the allocation of the use of individual facilities, since the specific impact of a new line on the compensations and the charges for the different countries can be perfectly identified.

Since the proposed long-term mechanism makes use of the historical flows in the year $N-1$ for the computation of the compensations and the charges to be applied during the year N , there is no need to make estimations of the future flow patterns or the precise dates of incorporation of a new transmission facility.

6 Conclusions and recommendations

This chapter presents the conclusions of this study on cost components of cross-border exchanges of electricity. The study starts from the conclusions on cross-border tarification of the Florence Regulatory Forum and critically evaluates several alternative schemes for determination of the elements of cost that must be employed in the long-term scheme of implementation of the mechanism of inter-TSO payments.

The report does not directly deal with the questions of: a) how to value the cost of existing and future network assets; b) how to collect or to distribute inter-TSO payments for final network users, i.e. beyond the TSO or country level; c) how to allocate the total network costs to final network users, thereby resulting in detailed locational signals, although some elements to perform these tasks have been provided.

Inter-TSO payments are meant to compensate those countries that incur into extra costs because of cross-border trade and to charge the countries that are responsible for these costs. It is a compensatory mechanism at country level. The reasons for the compensations are the losses and the network utilization in third countries that are created by cross-border transactions and loop flows⁵⁶.

The implementation of the mechanism of inter-TSO payments requires that the three following steps get done: i) computation of the compensation that is due to each country; ii) determination of the charges that each country has to pay to compensate others, and iii) allocation of the results of the two previous steps for any country in its national transmission tariffs G (for generators) and L (for consumers), thereby providing some location signals at EU level.

This report has examined different methods that facilitate the realization of these three tasks, as well as the data requirements for each one of them. Computer programs have been developed and data to apply them to relevant models of the Internal Electricity Market (IEM) have been collected, so that each method could be properly evaluated, both qualitatively and quantitatively.

The major conclusion of the study is that algorithms that are based on real flow network models can be used for the computation of inter-TSO payments and they are far superior to the present provisional mechanism. Data requirements to feed these models are demanding but feasible. A few alternative options exist regarding the specific algorithm to be used, with each one of them reflecting different

⁵⁶ At the Florence Forum the regulators have accepted to allow compensations for network utilization of new investments and “appropriate levels of the existing network”. Therefore some thresholds or limits on the compensations for the existing facilities might be established. However, the more reliable and objective the algorithms to compute compensations and charges are, the smaller is the need for these thresholds.

underlying regulatory criteria and resulting in outcomes with significant numerical differences.

The considered options can be grouped into two major categories, with each one of them offering several variations: a) methods that are based on the allocation of the electrical use of each individual network facility, with the method of average participations being the proposed choice, and b) methods that directly compute the compensations on the basis of the impact of transit flows, where the most representative case is the “with and without transit” algorithm. The study has identified the pros and cons of each option and it is left to regulators to make a final choice on the basis of this evaluation.

Among the proposed algorithms for network cost allocation, the average participations method can help also in obtaining solutions to other relevant regulatory questions, such as the assignment of the inter-TSO payments to the G and L tariffs, the harmonization of tariffs across the IEM and, mainly, the allocation of the costs of new network investments. This feature should be seen with much interest, since consistency among the solutions that are provided to the different regulatory network issues must be seen as a priority.

The detailed conclusions of the report can be grouped into two major categories. The first one concerns the data requirements. The second one refers to the qualitative and quantitative evaluation of each method.

6.1 Conclusions regarding data requirements Current availability and future solutions

Data collection and validation

Despite the positive cooperation of ETSO and its member organizations, the process of data collection, validation and utilization has been slow and laborious. During the established duration of the project, the contractor has been able to run only one scenario with the data that have been formally provided by ETSO, and not for the entire IEM, but for just the UCTE system. Some assumptions and simplifications have been made since some of the required data were not available. For instance, all lines have been assumed to be of equal length. Also, when a line crosses a border it has been assumed that half of it corresponds to each one of the countries. Additionally, all the lines in the system have been considered to be single circuit lines. Of course this is not true but it allows us to make some good estimations of the results that would be obtained if the real network system had been used to make all the computations. Lack of consistency between the data of the few scenarios that have been made available and difficulties because the data needed skilful handling before they could be employed in any useful form, have prevented that results for more scenarios could be presented in this report. This does not invalidate the methodological conclusions of the study, but it prevents us from inferring valid quantitative estimates on inter-TSO payments from our results for a single scenario.

The practical problems that the contractor has experienced could be reduced to almost zero with adequate standardized procedures of data collection and validation. It has to be realized that network cost allocation, —or any other major

tasks with mostly economic implications—, have not been part of the responsibilities of ETSO organizations such as UCTE, who are mostly devoted to operational and security issues.

In order to be able to start with a long-term mechanism for inter-TSO payments that is based on real flow network models, ETSO must make available the human and computational resources, as well as implement procedures for systematic data collection and handling that are needed for this task.

The data requirements should be clear by now. The technical feasibility of systematic data collection and validation is demonstrated by the fact that four of the countries belonging to the IEM, —the NORDEL countries: Denmark, Finland, Norway and Sweden—, have already implemented this same scheme for the allocation of network losses since January 1st, 2002, with hourly scenarios. What remains is the institutional decision by ETSO, properly supported by the regulators of the different countries and the EU Commission.

The number of scenarios

Real flow network models require the utilization of a representative number of scenarios in order to be able to provide meaningful quantitative results. Undoubtedly, the best option is to use 8,760 hourly scenarios corresponding to the historical system behavior for the last available year, as explained at the beginning of chapter 4. This is what NORDEL is presently using for network loss allocation.

However, collecting real flow data for every hour may be too demanding at the outset. This study has examined the possibility of using instead a reduced number of representative scenarios, conveniently weighed according to the number of hours that each one of them appears to represent. Despite the paucity of the data that have been made available for this analysis (two figures per hour for each country: internal demand and the net value of exports minus imports), clustering techniques have shown that an acceptably low number of scenarios (about twelve) suffices to describe all the patterns of export and import flows in the entire year. However, it remains to be proved that network utilization factors correlate well with patterns of import and export flows.

In conclusion, it is recommended to use 8,760 hourly historical scenarios of the last available complete year. This would eliminate any discussion on the procedure of selection of any reduced set of scenarios. However, if it is deemed that such a reduced number of representative scenarios should be employed instead, this study indicates that it seems plausible that these representative scenarios exist and that they could be determined via the clustering techniques that have been presented in this report.

A more conclusive evaluation of the precision of the approach would need a much more abundant provision of data than the one that has been made available.

A pragmatic recommendation, regarding the implementation of the long-term mechanism by January 2003, is to determine a provisional estimate of the values of the inter-TSO payments for the year 2003 on the basis of any available scenarios.

Systematic data collection should start as soon as possible and not later than January 1st 2003. Assuming January 1st 2003 is the starting date, and based on the data collected for 2003, it would be possible to decide that a revision of the provisional estimate would be done at the end of 2003 and the provisional inter-TSO payments would be adjusted accordingly.

6.2 Conclusions regarding the evaluation of the considered algorithms

A comparative analysis of the numerical results

We must start this section with a word of warning: The numbers in the report are based on the analysis of a single scenario. Therefore, they can be considered only for the purpose of comparison between network cost allocation algorithms, and not to infer the final results of compensations, charges and inter-TSO payments among countries.

Table 19, Table 20 and Table 21 summarize the results that have been obtained with five out of the six considered methods for the allocation of network infrastructure costs: average participations (AP), simplified average participations (SAP), modified average participations (MAP), the “with and without transit” method (WWT) and average participations applied to transits (APT). All figures in these tables correspond to percentages of the total number of equivalent 400 kV lines in the considered UCTE network model, as the tables of chapter 5 : The number of 400 kV equivalent lines in the considered case happens to be 3,655 lines.

Complete numerical results for the method of marginal participations (MP) have not been obtained, since the method was preliminarily discarded from the point of view of calculating inter-TSO payments, because of other considerations: too much dependence of arbitrary modeling decisions, —such as the choice of reference node—, and inability to reflect the actual flow patterns and the limited network capacities.

A first impression from observation of the tables is that significant numerical differences exist between the methods, although some persistent patterns of behavior can be easily identified⁵⁷. For instance, heavily importing or exporting countries, such as Italy or France, respectively, have large compensations (except in the WWT and APT methods) but even larger charges, resulting in significant negative inter-TSO payments, i.e. they have to pay. On the other hand, well balanced and heavily transited countries such as Switzerland have large compensations and small charges (this effect is emphasized in the MAP, WWT and APT methods), therefore resulting in large positive inter-TSO payments, i.e. they are paid by others⁵⁸.

⁵⁷ It is recalled here that the results for the AP and WWT methods can be only compared for the net inter-TSO payments, but not for compensations or losses separately, as explained in section 3.1.5.

⁵⁸ Note that this result cannot be extended to all possible cases of well balanced and “heavily transited” countries, if ETSO’s definition of transit is used since, by definition, the results of real flow network models depend on the internal pattern of flows in the country, while ETSO’s definition of transit does not. One could imagine a country with a non connected network, as in the lower part of Figure 7, where the net outcome of real flow network models would be negative for the country.

The pattern is less clear for countries that are simultaneously being transited while they also are net exporters or importers. This is for instance the case of Germany or Portugal, where the outcome of the WWT method for the net inter-TSO payments is opposite to the results of all the other algorithms, and also the case of The Netherlands, where AP is the only method in opposition to all the others.

It is also interesting to observe how the MAP and the APT methods tend to reduce the charges for well balanced countries, —i.e. countries with approximately the same volume of internal demand and generation—, and the similarity of their results for the net values of inter-TSO payments. APT treats disfavorably purely exporting or importing countries, as indicated in section 5.2.6 and confirmed with the results in Table 19, Table 20 and Table 21.

	E	P	F	I	CH	D	B	NL	SLO	A	CZ	PL	BIH	HR	H	SK	UA
AP	0.35	0.11	0.87	0.73	1.11	1.34	0.22	0.39	0.11	0.44	0.21	0.18	0.08	0.16	0.13	0.22	0.03
SAP	0.24	0.06	1.70	1.01	1.00	1.70	0.31	0.33	0.11	0.40	0.20	0.20	0.00	0.08	0.13	0.20	0.02
MAP	0.21	0.05	0.54	0.48	0.90	0.99	0.21	0.01	0.05	0.14	0.07	0.01	0.00	0.10	0.05	0.16	0.01
WWT	-0.09	0.20	0.00	0.00	1.25	-0.30	0.08	0.09	0.10	0.32	0.07	0.02	0.16	0.25	0.12	0.05	0.00
APT	0.17	0.07	0.03	0.00	1.13	1.16	0.16	0.05	0.12	0.21	0.13	0.10	0.08	0.16	0.10	0.23	0.01

Table 19: Compensations due to countries because of network use

	E	P	F	I	CH	D	B	NL	SLO	A	CZ	PL	BIH	HR	H	SK	UA
AP	0.30	0.19	1.48	1.02	0.60	0.94	0.24	0.31	0.10	0.35	0.43	0.16	0.02	0.20	0.13	0.15	0.06
SAP	0.24	0.07	1.73	1.25	0.61	1.01	0.32	0.81	0.11	0.43	0.57	0.13	0.00	0.07	0.18	0.11	0.04
MAP	0.18	0.07	1.49	1.02	0.02	0.10	0.07	0.30	0.01	0.26	0.26	0.08	0.00	0.01	0.05	0.00	0.06
WWT	0.09	0.03	0.81	0.26	0.06	0.27	0.07	0.18	0.04	0.14	0.16	0.07	0.01	0.03	0.03	0.03	0.02
APT	0.09	0.10	0.84	0.64	0.17	0.44	0.03	0.32	0.05	0.30	0.36	0.17	0.02	0.16	0.10	0.07	0.05

Table 20: Charges to be paid by countries because of network use

	E	P	F	I	CH	D	B	NL	SLO	A	CZ	PL	BIH	HR	H	SK	UA
AP	0.05	-0.08	-0.61	-0.29	0.51	0.40	-0.02	0.07	0.01	0.09	-0.22	0.02	0.06	-0.04	0.01	0.07	-0.03
SAP	-0.01	-0.01	-0.04	-0.24	0.39	0.69	-0.01	-0.48	0.00	-0.03	-0.37	0.07	0.00	0.01	-0.05	0.09	-0.02
MAP	0.03	-0.02	-0.95	-0.54	0.89	0.89	0.14	-0.29	0.05	-0.11	-0.19	-0.08	0.00	0.09	-0.01	0.16	-0.05
WWT	-0.19	0.17	-0.81	-0.26	1.19	-0.57	0.01	-0.10	0.06	0.19	-0.08	-0.05	0.15	0.22	0.09	0.02	-0.02
APT	0.08	-0.02	-0.81	-0.64	0.96	0.72	0.13	-0.27	0.07	-0.09	-0.23	-0.07	0.06	0.00	-0.01	0.16	-0.04

Table 21: Inter-TSO payments because of network use

Table 22, Table 23 and Table 24 summarize the results that have been obtained with the six considered methods for the allocation of network losses: average participations (AP), modified average participations (MAP), marginal loss factors applied to complete border flows (MP), the “with and without transit” method

(WWT), marginal loss factors applied to transit flows (MPT) and average participations applied to transits (APT). All figures in the tables correspond to MW of losses.

In this case the dispersion of the results is even larger than for the allocation of the costs of network infrastructure. Systematic patterns of behavior have not been identified. Net inter-TSO payments with the AP method are generally smaller than with any other method, while the two methods that are based on marginal loss factors typically result in the largest inter-TSO payments. An explanation for this is the quadratic nature of the network losses and therefore the fact that marginal factors result in compensations that roughly double the actual amount of incurred losses.

	E	P	F	I	CH	D	B	NL	SLO	A	CZ	PL	BIH	HR	H	SK	UA
AP	15.9	8.0	51.4	35.5	24.9	43.7	6.2	17.5	3.3	11.5	6.8	4.4	4.3	4.3	3.0	2.3	0.2
MAP	9.4	2.8	33.4	23.0	22.2	35.3	6.0	0.5	1.7	3.9	2.4	0.0	0.1	1.9	0.9	1.8	0.1
MP	26.7	19.9	28.9	10.0	91.8	97.0	21.6	9.1	17.0	30.2	25.5	6.0	14.5	13.0	14.4	10.4	0.9
WWT	-20.4	5.0	-16.0	0.0	15.1	-38.5	-1.1	2.3	-2.8	7.9	-4.1	-3.3	8.0	-69.6	1.0	-8.6	0.0
MPT	-17.8	2.9	-4.1	0.0	31.6	23.3	-1.5	0.4	-2.7	5.8	-0.8	-2.4	7.9	-9.7	0.3	-3.1	0.0
APT	6.9	6.0	1.7	0.0	25.1	37.0	5.0	2.2	3.2	5.1	4.0	2.5	4.3	4.3	2.5	2.4	0.1

Table 22: Compensations for losses due to countries

	E	P	F	I	CH	D	B	NL	SLO	A	CZ	PL	BIH	HR	H	SK	UA
AP	20.1	9.6	50.8	40.7	19.9	30.6	13.3	13.2	1.7	11.7	13.9	3.7	1.0	7.6	2.0	2.9	0.5
MAP	11.0	4.0	49.5	40.4	0.5	3.2	3.7	12.9	0.1	8.5	8.1	2.2	0.0	0.3	0.5	0.0	0.5
MP	23.9	21.0	77.6	88.0	17.1	24.3	17.8	46.1	13.9	0.5	42.4	26.0	0.4	17.4	4.3	12.3	4.1
WWT	-4.4	-2.0	-38.6	-14.8	-8.4	-9.6	-4.3	-11.3	-2.3	-9.9	-9.2	-3.9	-0.4	-1.0	-2.0	-1.5	-1.4
MPT	-0.4	-13.0	14.4	25.7	1.4	-2.7	1.7	8.3	0.9	-5.9	9.2	-1.0	-10.0	3.6	-3.5	2.6	-1.0
APT	6.7	4.4	22.2	18.5	2.2	8.7	2.0	13.3	1.0	7.8	10.7	3.8	1.0	6.8	1.7	1.2	0.3

Table 23: Charges to be paid by countries because of losses

	E	P	F	I	CH	D	B	NL	SLO	A	CZ	PL	BIH	HR	H	SK	UA
AP	-4.2	-1.6	0.6	-5.2	5.0	13.1	-7.1	4.3	1.6	-0.2	-7.1	0.7	3.3	-3.3	1.0	-0.6	-0.3
MAP	-1.6	-1.2	-16.1	-17.4	21.7	32.1	2.3	-12.4	1.6	-4.6	-5.7	-2.2	0.1	1.6	0.4	1.8	-0.4
MP	2.8	-1.0	-48.7	-78.0	74.7	72.7	3.8	-37.0	3.1	29.7	-17.0	-20.0	14.1	-4.4	10.1	-1.9	-3.2
WWT	-16.0	7.0	22.6	14.8	23.6	-28.9	3.2	13.6	-0.5	17.8	5.0	0.6	8.5	-68.5	3.0	-7.1	1.4
MPT	-17.4	15.9	-18.5	-25.7	30.2	26.0	-3.1	-7.9	-3.6	11.7	-10.0	-1.4	17.9	-13.3	3.8	-5.7	1.0
APT	0.2	1.6	-20.5	-18.5	22.9	28.3	3.0	-11.1	2.2	-2.7	-6.7	-1.3	3.3	-2.5	0.8	1.2	-0.2

Table 24: Inter-TSO payments because of losses

A first estimate of the economic implications of each method

In order to have a rough idea of the order of magnitude of the volume of economic compensations, charges and inter-TSO payments with the different methods, the numerical results in the previous section have been applied to estimated average lengths of lines (the same length for all lines) and to standard regulated costs of lines that have been derived from the current Spanish regulation (see section 5.2.1 for more details). These values are different from the ones that have been used by ETSO in the provisional algorithm and correspond to an estimation that has been made of representative values of the system. The word of caution has to be repeated here: not only we are using the figures from a single scenario, but we are also employing a first estimation of the values of costs and lengths of the lines. However, the results will be useful to establish some additional comparisons among the different methods and to guess the order of magnitude of the expected outcome of application of the different algorithms.

Table 25, Table 26 and Table 27 on one hand and Table 28, Table 29 and Table 30 on the other hand, present the results of this analysis for infrastructure costs and the costs of losses, respectively. The figures now are expressed as millions of euros. The evaluation is limited to the 9 countries of the IEM within the UCTE. Every 400 kV equivalent line of the system has been considered to be 50 Km long and to have a regulated annual cost of 0.653 million euros (0.01306 million euros per Km of line). The values of annual losses in GWh for each country are given in row LOS in Table 28 and the per unit costs of energy in euros/MWh in row CE below. From these basic data, the compensations, charges and inter-TSO payments can now be easily computed, where all 8760 hours in the year have been considered to be equal to the single one hourly snapshot whose network flows have been analyzed.

One more method has been added to the evaluation: the provisional method (PM) of ETSO, but now applied only to the single available scenario, so that it can be compared to the real flow network methods being examined⁵⁹.

As expected, the results show that the average participations method (AP) will have a larger volume of compensations than others apart from the simplified average participations model (SAP)⁶⁰. However, what matters is not the intermediate values of compensations and charges, but the values of net inter-TSO payments, i.e. the volume of money that, in the end, each country will have to receive or to pay, because of the inter-TSO payment mechanism. This is shown in Table 27, where the leftmost column shows the sum of the *absolute* values of the figures in the corresponding rows, i.e. the net payments that are received or paid by each country. And the results show that most methods have a similar figure of aggregated inter-TSO payments, with average participations (AP) being among the lowest ones and the provisional method (PM) being the highest.

⁵⁹ Note that the PM method does not result now in compensations for 200 million euros, but 258 million euros instead, since it is not applied to a set of 8,760 scenarios, but only to the single hourly snapshot of network flows that has been made available, and then the result is multiplied by 8760.

⁶⁰ This was explained in sections 3.1.1 and 3.1.5: AP gives compensations to countries without transits, while WWT does not.

	E	P	F	I	CH	D	B	NL	A	TOTAL
AP	8.4	2.6	20.8	17.4	26.5	32.1	5.3	9.2	10.4	132.8
SAP	5.6	1.4	40.2	24.0	23.8	40.4	7.4	7.8	9.5	160.2
MAP	5.0	1.2	12.9	11.5	21.6	23.8	5.0	0.3	3.5	84.7
WWT	-2.3	4.7	-0.1	0.0	29.8	-7.1	2.0	2.1	7.7	55.8
APT	4.0	1.8	0.7	0.0	27.2	27.9	3.9	1.1	5.1	71.6
PM(9)	4.8	2.7	2.1	0.0	27.7	40.9	7.0	1.4	6.4	93.2

Table 25: Total economic compensations (M€) of network infrastructure costs

	E	P	F	I	CH	D	B	NL	A	TOTAL
AP	7.2	4.6	35.3	24.4	14.4	22.5	5.7	7.4	8.3	129.9
SAP	5.8	1.7	41.1	29.7	14.5	24.0	7.6	19.1	10.3	153.8
MAP	4.2	1.7	35.7	24.5	0.4	2.4	1.6	7.2	6.2	83.8
WWT	2.2	0.7	19.4	6.1	1.4	6.6	1.7	4.4	3.3	45.9
APT	2.1	2.4	20.2	15.3	4.2	10.5	0.8	7.6	7.2	70.2
PM	4.3	2.1	31.0	10.0	5.0	9.2	3.2	7.3	6.2	78.4

Table 26: Total economic charges (M€) because of network infrastructure costs

	E	P	F	I	CH	D	B	NL	A	TOTAL
AP	1.2	-2.0	-14.6	-7.0	12.1	9.5	-0.5	1.8	2.2	50.8
SAP	-0.2	-0.3	-0.9	-5.7	9.3	16.5	-0.2	-11.3	-0.7	45.1
MAP	0.8	-0.5	-22.7	-13.0	21.2	21.4	3.3	-6.9	-2.7	92.7
WWT	-4.5	4.0	-19.5	-6.1	28.4	-13.7	0.3	-2.3	4.4	83.1
APT	1.9	-0.6	-19.5	-15.3	23.0	17.4	3.1	-6.5	-2.1	89.4
PM	0.5	0.6	-28.9	-10.0	22.7	31.7	3.8	-5.9	0.3	104.3

Table 27: Total volume of inter-TSO payments (M€) for network infrastructure costs

The results in the tables show the reduced quantitative importance of the compensations, the charges and, particularly, the inter-TSO payments associated to losses, —for most of the considered methods—, when compared to the corresponding values for the network infrastructure costs. The AP method results in the lowest value, among all methods, for the inter-TSO payments that are derived from network losses.

	E	P	F	I	CH	D	B	NL	A	TOTAL
AP	3.17	0.85	10.37	7.84	8.64	9.62	3.02	3.70	5.77	52.99
MAP	1.87	0.29	6.72	5.06	7.58	7.74	2.92	0.10	1.95	34.25
MP	5.32	2.10	5.82	2.20	31.36	21.19	10.52	1.90	15.15	95.56
WWT	-4.06	0.53	-3.21	0.00	5.23	-8.45	-0.54	0.48	3.99	26.49
MPT	-3.53	0.31	-0.83	0.00	10.79	5.08	-0.71	0.08	2.88	24.22
APT	1.37	0.63	0.34	0.00	8.57	8.11	2.44	0.46	2.55	24.48
PM	1.83	0.78	0.61	0.00	8.00	8.61	2.79	0.50	3.68	26.81
LOS	2600	386	5500	2050	680	3180	580	450	575	
CE	37.50	43.30	32.70	33.20	37.50	31.80	37.50	45.00	41.70	

Table 28: Total economic compensations (M€) of losses

	E	P	F	I	CH	D	B	NL	A	TOTAL
AP	3.29	1.92	12.56	11.12	4.47	9.26	2.74	3.78	2.98	52.12
MAP	1.94	0.80	12.23	10.96	0.11	1.17	0.75	3.71	2.10	33.77
MP	2.89	4.17	20.35	28.72	5.23	8.88	3.63	14.89	0.12	88.89
WWT	-1.16	-0.50	-10.19	-3.75	-2.22	-2.57	-1.08	-2.85	-2.64	26.95
MPT	-0.36	-2.59	3.29	8.72	0.38	-0.73	0.35	2.17	-1.48	20.07
APT	0.77	0.88	6.06	6.23	0.53	3.10	0.42	3.79	2.06	23.84
PM	1.32	0.81	11.93	3.84	1.94	3.56	1.24	2.82	2.37	29.84

Table 29: Total economic charges (M€) because of losses

	E	P	F	I	CH	D	B	NL	A	TOTAL
AP	-0.11	-1.07	-2.19	-3.28	4.17	0.36	0.28	-0.09	2.80	14.35
MAP	-0.07	-0.50	-5.51	-5.90	7.47	6.57	2.17	-3.61	-0.15	31.95
MP	2.42	-2.07	-14.52	-26.52	26.13	12.31	6.88	-12.99	15.03	118.87
WWT	-2.90	1.03	6.98	3.75	7.45	-5.88	0.53	3.33	6.63	38.47
MPT	-3.17	2.90	-4.12	-8.72	10.41	5.81	-1.06	-2.09	4.36	42.64
APT	0.60	-0.24	-5.71	-6.23	8.04	5.01	2.01	-3.33	0.49	31.68
PM	0.50	-0.03	-11.31	-3.84	6.06	5.05	1.55	-2.32	1.31	31.98

Table 30: Total volume of inter-TSO payments (M€) for losses

A comparative evaluation of the considered methods

In the end, the final comparison has to be made between two basic approaches: the average participations (AP) method, with the modified average participation (MAP) method as an interesting variant, and the “with and without transit “ (WWT)

method, with the method of average participations applied to transits (APT) also as a variant.

The simplified average participations (SAP) method should be discarded from the outset, since it is only a simplified version of the AP method and the observed lack of accuracy in the numerical results indicate that the method appears to be unacceptable. The method of marginal participations (MP) should be also abandoned from the point of view of calculating inter-TSO compensation payments, because of the dependence of its results on the choice of a reference node and also because of its inability to reflect the actual patterns of flow and the capacity of the interconnections. The two methods for dealing with losses by means of marginal loss factors will also be ignored, since they also depend on the choice of the reference node and, specially, since they cannot be applied to the allocation of infrastructure costs. This is a major drawback, since it is far simpler to deal with a single method for both purposes and also because losses represent a small fraction of the volume of payments that are derived from network infrastructure costs.

Although none of the remaining methods can be proved to provide the indisputable solution to the problem of allocation of network costs, the comprehensive examination of the performance of the methods allows one to clearly identify winners and losers. Let us concentrate first on the “with and without transits” approach and the method of average participations. Both rely on reasonable heuristic assumptions. They have arrived to the “grand finale” because they have not incurred into serious disqualifying flaws as the other contenders have done. They also have some interesting properties. It follows a summary of their strong and weak points, which have been already commented in sections 3.1.1 and 5.2.1 for the AP method and in sections 3.1.5 and 5.2.5 for WWT.

- The AP method is fully consistent with the “single system paradigm”, i.e. it is based on nodal transmission tariffs that are computed, just for the purpose of the inter-TSO mechanism, by the allocation of the electrical use of each transmission facility, with independence of the political borders or configurations of TSOs. On the other hand the WWT method is specifically based on the definition of transit for each country or TSO, which is a concept that directly depends on the flows at the political borders and only makes use of a fraction of these flows. WWT therefore departs from the “single system paradigm” and implies a special treatment for a certain type of flows: the transits, with their ad hoc and controversial definition. The procedures of the WWT method, as well as its results, are very dependent on political borders between countries, or boundaries between TSOs. The “with and without transit” approach appears to be deeply ingrained in the philosophy that the member organizations of ETSO have maintained in the past in similar activities and this may facilitate the acceptance of the method. NORDEL has already started to use WWT for internal loss allocation within the Scandinavian region. On the other hand, the WWT method is not fully consistent with the long term goal of a single market where the impact of political borders should become progressively weaker.
- Both methods start off from some heuristic and reasonable assumptions. The WWT method makes use of the intuitive but ambiguous concept of “transit” of a country and adopts a definition for it. Then the compensation for each country

is defined on the basis of a comparison between the network utilization and the losses in two operating conditions: the actual one and an artificial one where the “transit” is removed. The AP method assumes that it is possible to trace the origin and the end of the flows and applies a simple proportionality branching rule for this purpose. The essential advantage of this approach is that, once the flow tracing rule has been accepted, everything else directly follows: nodal transmission tariffs, compensations, charges, inter-TSO payments and their assignment to the local G and L charges, allocation of the costs of new investments, and so on. On the other hand, the WWT method requires of additional assumptions or ad hoc rules in order to determine charges and inter-TSO payments, or to assign the costs of a new network investment. As it is now, the allocation of charges in WWT performed by NORDEL ignores the topology of the IEM system and spreads the charges of any country over most other countries. It is particularly serious that WWT only computes compensations, and other method (such as the one currently used by NORDEL which happens to be unsatisfactory as we have just explained) has to be devised in order to determine the charges and inter-TSO payments. Undoubtedly, some parties or institutions may prefer the ambiguity and space for negotiation that the WWT method provides to the transparency and determinism of the AP approach, but this should not be seriously considered as a methodological advantage.

- Both methods yield numerical results that, in general, make economic and engineering sense. The results for both methods are different, although there are important similarities in broad terms, i.e., which countries should receive the largest compensations or which ones should pay the most. These discrepancies were expected, since both methods have essential differences: AP is based on the complete physical flows, while WWT looks for the impact of just the transit flows at the borders between countries and it ignores the physical flows in the allocation of charges. This is why purely exporting or importing countries receive compensations in the AP method⁶¹, while these non transited countries have zero compensations with WWT. In quantitative terms, both methods can only be compared on the basis of the final net inter-TSO payments that result from the application of compensations and losses to each country.
- Despite the methodological differences, both methods have provided inter-TSO payments of almost the same global economic volume⁶², —and both lower than with the provisional method—, when applied to the single scenario that has been examined in detail.
- Both methods allow some flexibility in their implementation. This is an issue that has not been explored sufficiently in this study, but it should be done for the approach that will be finally adopted. For instance, the AP algorithm could be applied only to the allocation of the fraction of the transmission facilities that is actually in use in the considered scenario (e.g. a line with a capacity of

⁶¹ They are also assigned charges, which typically exceed the compensations, therefore resulting in negative net inter-TSO payments.

⁶² See Table 27 and Table 30.

1,000 MW may have an actual flow of only 300 MW). The remaining part could be allocated in a different way, perhaps allowing more flexibility in tariff harmonization guidelines⁶³. In the same way, in WWT the specification of the measure of network utilization to be used in the computation of the differences of the “with and without transits” situations provides degrees of freedom that may be used for the same purpose.

- Data requirements are similar for both methods, since they make use of real network flows for a representative number of scenarios. There are, however, some differences. The WWT method needs to run two sets of individual load flows (one with the transit and the other without it) for each country. Obviously, the data for all countries should be consistent, since all of them correspond to the same scenario, but a model of the complete IEM network is never needed. On the other hand, the data for each country should be of enough quality so that a load flow model is able to systematically converge, without the need of specialized human inspection, since these computations will be very repetitive. In this respect, some concern must be expressed regarding the “without transits” situations, since they do not correspond to any physical existing pattern of flows and, —because of the assumptions that have to be made, such as the pro rata assignment of the transit flows when there are several interconnections—, bizarre results are to be expected. On the other hand, the AP method needs a complete snapshot of the actual flows in the IEM network, with consistency in the flows at the interconnections when seen from both sides of the border, but the method does not need to run any load flow, since it is only based on simple rules of tracing flows. Therefore no special quality is required of the data and no computational trouble is to be expected when running many scenarios in an automatic mode.
- Cross-border tarification is just one among several pieces of the puzzle of transmission regulation in the IEM, with others being harmonization of tariffs, congestion management and treatment of new investments. It should therefore be positively valued that the network cost allocation method that is adopted for the computation of inter-TSO payments could eventually be used also as a guide in establishing harmonization criteria of transmission tariffs in the IEM or in the allocation of the inter-TSO payments to the G and L local tariffs, as well as in the assignment of the cost of a new network investment among its users. The AP method can be used, if desired, as an aid in performing these tasks, while WWT can exclusively be used for the computation of compensations to countries because of transits. This feature will become very relevant shortly, in the discussion of the allocation of the costs of new network reinforcements. This issue is automatically taken care of in the AP method by just including the new investment in the real network flow model.
- Because it is based on transits, the WWT method tends to *emphasize* the support to transited countries at the expense of mostly exporting or importing countries, while the AP method is more neutral in this respect. This may be at odds with some of the conclusions of the Florence Regulatory Forum, and in

⁶³ For instance, the non used part could be socialized to all consumers in the country or TSO where the transmission facility is located.

particular with the request by the regulators that also the commercial and security related benefits of transits and interconnections should be somehow accounted for in the final evaluation. Another issue is related with the exclusive utilization of transits in WWT versus employing the complete cross-border flows in AP. It was concluded at the 8th Florence Forum that “cost and benefits from cross-border flows, covering in principle losses, new investments and appropriate levels of existing investments, will be compensated via an inter-TSO mechanism based on physical flows”. The emphasis on “physical flows” appears to disfavor methods that are just based on transits. However, it must be recognized that in the same 8th Florence Forum it was also concluded that “a more precise estimate of the extent to which different generators and loads are likely to generate transit flows –on the basis of real network models— is necessary in order to come closer to cost reflectiveness and to the right locational signals”.

In conclusion, it seems fair to say that in most of the considered categories for comparison the AP method appears to be superior to WWT. The variants to both AP and WWT methods must be also commented. As explained in section 3.1.3, MAP responds to a potential criticism to the AP method, when examined with a “non single system paradigm” mentality: small and heavily transited countries that are well balanced in generation and demand may happen to use much other countries’ networks and end up with small or even negative net inter-TSO payments. This may very well happen, -although it has not been the case in the scenario that has been examined in this study⁶⁴-, and the AP method provides the correct answer under a “single system paradigm” perspective. The modified average participations (MAP) method addresses this problem by a modification in the original AP method so that only the global imbalance between generation and demand in any given country may result in its utilization of external networks. The numerical results that have been obtained confirm that the MAP method achieves the purpose for which it has been conceived. It is obviously a regulatory matter whether to accept or not temporarily this potential criticism to the AP method, while the “single system paradigm” mentality becomes fully implemented. Note the points in common with the discussion above about the potential discrepancies of the WWT method with some of the recommendations of the Florence Forum.

The other variant, —now with respect to the WWT method—, is the average participations applied to transits (APT) method. As explained in section 3.1.6, APT tries to eliminate some practical implementation difficulties of the WWT algorithm, while preserving the same philosophy of relating all external network use to the concept of transit. On the other hand, APT may treat unfavorably purely importing or exporting countries. APT does not require the specification or utilization of a “without transit” operating condition and APT is able to identify the responsibilities for the transits, therefore providing a solution to the problem of allocation of the charges, which the WWT method is unable to address. It is also interesting that the APT method does not require the use of load flows and therefore the pressure on the quality of data and human verification of the results

⁶⁴ See for instance the numerical results of the AP method for Switzerland in section 5.2.1.

is significantly reduced. The APT and MAP methods yield numerical results that are very similar for the considered scenario, more than APT and WWT (this was to be expected, since WWT uses an ad hoc method for allocation of charges).

The advantages of APT with respect to WWT deserve that the APT method should be seriously considered as a preferred candidate to the WWT method. However, APT is not free from criticism: It relies on the ambiguous concept of transit and results in no compensations, but normal charges, for purely importing or exporting countries, which therefore tend to be unfavorably treated. Although APT is a new algorithm that has been developed during the course of this project, no impediment has been identified so that it could not be regarded as a solid alternative to WWT. An additional case example (the NORDEL system) has been run to gain more experience with the application of the APT method (see Annex 7) and the results confirm the above conclusions.

Overall conclusions

When all the above considerations are jointly considered, this study must conclude that the method of average participations (AP) is clearly the preferred approach, among all the methods that were initially selected as potential candidates to perform the task of allocation of network charges, in the computation of inter-TSO payments.

Despite some shortcomings, —in particular its inability to provide a solution to the computation of charges, its bias towards transited countries and potential inconsistencies with the guidelines of the Florence Forum, the “with and without transit” (WWT) method would represent a considerable improvement over the provisional approach, depending of course on the adopted procedure to compute the charges. This study has proposed a variant of WWT, —the method of average participations applied to transits (APT)—, that appears to provide solutions to some of the practical implementation difficulties of the WWT method. Therefore, in case the family of “with and without transits” approaches is adopted for the task of computation of inter-TSO payments, the APT method should be given due consideration.

7 Bibliography

[Bialek, 1996]

J. Bialek, "Tracing the flow of electricity", IEE Proceedings on Generation, Transmission and Distribution, vol. 143, July 1996.

[Kirschen et al, 1993]

D. Kirschen, R. Allan, G. Strbac, "Contributions of individual generators to loads and flows", IEEE Transactions on Power Systems, Vol. 12, No. 1, Feb. 1997.

[Martinetz et al, 1993]

T.M. Martinetz, S.G. Berkovich and K.J. Schulten, "Neural-gas network for vector quantization and its application to time-series prediction", IEEE Transactions on Neural Networks, 4(4), pag. 558-569, 1993

[Muñoz, 2001]

A. Muñoz, "Aplicación de técnicas de redes neuronales artificiales al diagnóstico de procesos industriales", Doctoral Dissertation, Universidad Pontificia Comillas, Madrid 1996.

[Pérez-Arriaga et al, 1995]

I.J. Pérez-Arriaga, F.J. Rubio Odériz., "Marginal pricing of transmission services: An analysis of cost recovery", IEEE Transactions on Power Systems, vol. 10, no. 1, Feb. 1995.

[Perán et al, 2001]

Perán, F., Pérez-Arriaga, I.J., "Allocation of transmission losses among the systems of a regional electricity market", paper 166, 7 Jornadas Hispano Lusas de Ingeniería Eléctrica, Madrid, July 2001 (in Spanish).

[Pérez-Arriaga et al, 2001]

I.J. Pérez-Arriaga, F.J. Rubio, F. Perán, "Benchmark of electricity transmission tariffs", report prepared for DG TREN of the EU Commission by IIT, Comillas University, March 2001.

[Pérez-Arriaga, 2002]

I.J. Pérez-Arriaga, "Methodology for cross-border tarification in the Internal Electricity Market of the European Union", Proceedings 15th PSCC Conference, Seville, June 2002.

[Rivier et al, 1993]

M. Rivier, I.J. Pérez-Arriaga., "Computation and decomposition of spot prices for transmission pricing", Proceedings 11th PSCC Conference, pp. 371-378, Avignon, 1993.

[Rubio et al, 2000]

F.J. Rubio Odériz., I.J. Pérez-Arriaga, “Marginal pricing of transmission services: A comparative analysis of network cost allocation methods”, IEEE Transactions on Power Systems, vol 15, no. 1, Feb. 2000.

[Utilities Policy, 1997]

Utilities Policy, “Special issue on transmission pricing”, Utilities Policy, volume 6, number 3, September 1997.

[Vázquez et al, 2002]

C. Vázquez., L. Olmos, I.J. Pérez-Arriaga, “On the choice of slack bus in mechanisms for transmission network cost allocation that are based on network utilization”, Proceedings 15th PSCC Conference, Seville, June 2002.

[Schweppe et al, 1988]

F. Schweppe, M. Caramanis., R. Tabors., R. Bohn, “Spot pricing of electricity”, Kluwer Academic Publishers, 1988.

Annex 1. The Florence process

This annex provides a schematic description of the evolution of the conclusions and the viewpoints of the agents during the Florence process, so it is easier to understand how we have arrived to the present situation. Numerous agents have intervened in the Florence Regulatory Forum and, in most cases, their positions have evolved with time. Along the process, agreement has been reached on major issues, with the discrepancies being progressively reduced. The major points of consensus have been reflected in the conclusions of the Florence meetings. Here, in order to summarize, only the positions of regulators and ETSO will be reflected, as well as the most significant conclusions of the Florence meetings, and only on the issue of cross-border tariffication. A brief account of the major points of agreement that have been reached so far must include the following ones:

- i) Separate treatment of network pricing (cross-border tariffication) and congestion management.
- ii) The local connection charge G (for generators) and L (for consumers) provides access to the entire EU network. These charges must be independent on the commercial transactions. Some degree of harmonization of these charges is a medium term objective.
- iii) Revenues from all transmission related charges for a TSO must recover all its network costs.
- iv) Any regulatory charges in any particular country (e.g. stranded costs) can be only applied to domestic network users.
- v) The provisional system of cross-border pricing shall apply to the IEM countries in the synchronously interconnected UCTE network plus Switzerland. Separate arrangements may apply on a case by case basis to the DC interconnectors. Within each of these areas (such as NORDEL, the United Kingdom or Ireland), transmission pricing, while complying with the same general principles, may follow different approaches. The permanent CBT mechanism will apply to the 17 countries that presently participate in the IEM, i.e. the 15 EU countries plus Norway and Switzerland. Special arrangements will be established with perimeter countries.
- vi) An inter-TSO payment mechanism will be established to compensate those countries that incur into extra costs because of cross-border transactions and loop flows, while at the same time the mechanism charges the countries that are responsible for these flows. The long-term mechanism to be used must make use of the actual physical flows and real flow network models. The economic compensations and charges must be computed by using standardized costs of transmission facilities and energy losses.

- vii) Compensations and charges in the inter-TSO payment scheme will cover in principle losses, new investments and appropriate levels of existing investments.
- viii) The net result of applying the compensations and charges of the inter-TSO payment mechanism for any given country should be transferred to the domestic transmission tariffs G and L of this country. Any charges that are derived from the inter-TSO payments scheme must not depend on the specific commercial transactions among the market agents. Therefore, there shall be no extra tariffs for import, export or transit, providing that appropriate and efficient locational signals are in place.

Until recently, the major source of discrepancy at the Florence Forum has been the nature and volume of the inter-TSO payments. This is still a pending issue. The different positions will be presented now in a schematic way, since the aim here is not to produce an accurate historical review, but to provide an understanding of the existing alternatives. The different positions will be presented as they are, without any theoretical support.

i) Initial position of some regulators⁶⁵:

The network access tariff that is levied by a Member State to its qualified agents allows them also to engage into any kind of cross-border transaction within the EU. No other charges or compensations among TSOs are needed. Then, 0% of the costs of the existing network are attributed to cross-border transactions. The cost of future network investments that are needed because of international trade should be somehow shared by those who use them or benefit from them.

This position was later modified⁶⁶, in order to allow for some compensation to those TSOs that are subject to heavy cross-border transactions (CBT). The compensations could be recovered by some transit T charge, to be levied to all network users and/or partly to cross-border transactions.

ii) Initial position by ETSO:

ETSO proposed the use of the cost-component method, which tries to determine the costs of each TSO that are caused by CBT. The method includes a detailed account of these costs. Therefore, 100% of the fraction of the costs of the existing network that may be attributed to the use of CBT is charged to cross-border transactions. These costs could be recovered by some transit T charge, to be levied on cross-border transactions.

⁶⁵ This position was first presented by the Italian, Portuguese and Spanish regulators at the 2nd Florence meeting, October 1998. Other regulators supported this position, which was subsequently modified to allow for some compensatory schemes.

⁶⁶ At the 3rd Florence meeting.

iii) Conclusions of the 3th Florence meeting

“For network users any system of tariffication should be non-transaction based ... The basis of a system of cross-border tariffication methodology is input (generator) and output (consumer) tariffs ... Whilst a majority of those present recommend the avoidance of a separate transit element, the TSOs are invited to further consider this issue ... “

iv) Revised position of regulators⁶⁷

The scheme of cross-border tariffication should be based on the G and L access tariffs that are levied by each TSO. TSOs are entitled to receive some compensations (inter-TSO payments) from other TSOs because of incurred costs associated to CBT. These costs have two components:

- Share of the cost of future reinforcements attributable to CBT.
- Marginal losses (approximated by twice the average losses) attributable to CBT.

Responsibility of each TSO in these costs could be computed based on some measure of the import/export activity of each TSO and topological (location) considerations.

The net credit or charge for each TSO resulting from inter-TSO payments should be used to modify the revenue level from which the G and L charges of that TSO are derived

v) Conclusions of the 4th Florence Meeting

“The fundamental principle is that each TSO’s network costs will be mainly recovered through the G and L charges that are imposed upon local network users. These charges provide access to the complete interconnected EU network ... These network charges will be independent of the commercial transactions that the network users may engage in.”

“However, it is also recognized that the existence of cross-border transactions may cause individual power systems to incur some extra costs, and this fact justifies that some additional network charges could be recognized due to the existence of cross-border transactions ... The net credit or charge for each TSO resulting from inter-TSO payments will be used to modify the revenue level from which the G and L charges of that TSO are derived. How the individual G’s and L’s are affected will be left to subsidiarity, subject to applicable Community rules and in particular do not constitute an unjustified or unreasonable barrier to trade ... Whilst the specific details of the eventual methodology with respect to the calculation

⁶⁷ Expressed by a large group of regulators at the 4th Florence meeting. The CEER had not been created yet.

of CBT costs needs to be rapidly finalised, an approach based on a factor of losses incurred in each transmission system network due to international trade, should in principle form the basis of the final approach in this area.”

vi) Position of ETSO presented at the 5th Florence meeting

The cost component method should be used to determine the fraction of the cost of the HN of each TSO that will be recovered via inter-TSO payments. The allocation key to be used to determine this fraction is the ratio of transits to internal consumption in each TSO. As data on transits is not directly available, they are approximated as the minimum value of metered exports and metered imports.

In the ETSO proposal the funds necessary to pay for the compensation between TSOs are to be financed by a standard export stamp placed on all generation with a sink outside the country of origin (i.e. exporting generators).

Each TSO will apply the revenues internally using subsidiarity.

vii) Position of the CEER at the 5th Florence meeting

The position is basically coincident with the position presented at the 4th Florence meeting, but now allowing that TSO compensations could exceptionally include the costs of some specific investments of the existing network, in particular for those TSOs with a high ratio of transit flows to internal network use.

viii) Conclusions of the 5th Florence meeting and the Council of Energy Ministers concerning inter-TSO payments

“The establishment of a system based on payments between TSOs to compensate for the cost of physical flows of electricity in the form of transits and loop-flows, resulting from imports and exports in the Internal Electricity Market”.

The export stamp proposed by ETSO was not accepted: “It is however believed that, whilst this approach does have a number of advantages, it is not possible to fix, at this early stage, a simple harmonized system at Community level for raising the funds to finance inter-TSO compensation. At least at present, therefore, the question of the methodology for raising/disposing of funds within each TSO relating to cross-border tariffication compensation payments between TSOs should be left to subsidiarity ... subject to overall coordination and control by the European Commission to ensure that the potentially different approaches at Member State level do not result in distortion of the IEM”

“The European Commission, on the basis of a proposition by the CEER and discussions with ETSO, should put forward a proposal in this respect for discussion at the next Florence Forum ... Such a proposal should necessarily

be based on payments between TSOs to compensate for the cost of net physical flows of electricity in the form of transits and loop-flows, resulting from imports and exports in the IEM. Whilst the final details of this remain to be concluded, the basis of this approach should be a methodology centered upon the cost of losses and specific network assets of a clearly defined horizontal network. CBT related TSO payments should be based on the net physical flows associated with CBTs and should reflect locational factors”.

The Council of Energy Ministers on May 30, 2000, stated in its conclusions: “[The Council] stresses the need to ensure that thje levels of inter-TSO payments to enter in force by October 2000, as well as the systems for financing the payments, are refined and fully in line with the principles of non-discrimination, cost-reflectiveness, simplicity and transparency and are on a non-transaction basis”.

ix) Developments after the 5th Florence meeting:

- As requested in the conclusions of the 5th Florence meeting, ETSO provided additional information on the basis for its estimate of the global amount of inter-TSO compensations for the period from Oct-2000 to September 2001, and also raised the amount from 200 million euros to 250 million euros.
- Also as requested in the conclusions of the 5th Florence meeting, CEER submitted to the CE a position paper on the global fund of 250 million euros proposed by ETSO for inter-TSO compensations for the period from Oct-2000 to September 2001. Based on the data made available to the CEER, the CEER concluded that there were no validated arguments to rationally justify this amount or any other amount. The view of the CEER was that the amount was on the high side of the scales discussed, both compared to tentative figures calculated by the “two times losses” method and to the lower figure of 200 million euros put forward by ETSO itself at the 5th Florence meeting. The CEER does not agree with the allocation key utilized by ETSO in the computation of the fraction of the costs of the HN to be attributable to CBT, and proposes an alternative key.

x) The 6th and 7th Florence meetings⁶⁸

During these two meetings not much progress took place on new principles for the implementation of cross-border tarification. Advances were made on the related topics of congestion management, —mostly based on a proposal on a coordinated scheme by ETSO—, and increasing the awareness of the relevance of adequate network infrastructure for a successful implementation of the IEM. The institutions consolidated: not only CEER

⁶⁸ November 2000 and May 2001, respectively.

and ETSO, but also the associations of power exchanges, traders, large industrial consumers, local distributors and Euroelectric took active part at the Forum.

The sum of 200 million euros of compensations because of CBT was finally approved. The dates for the implementation of the provisional inter-TSO mechanism of ETSO were postponed several times. The most contentious issue was the method of allocation of the charges to the different countries, since the export fee on generators in the proposal by ETSO did not appear to be acceptable to some of the stakeholders.

In January 2001 the CEER presented a proposal to accelerate the liberalization of the European Internal Electricity Market. This proposal contained a set of guiding principles for the implementation of the conclusions of the Florence process. The CEER also issued a document establishing guidelines for transmission tariff harmonization.

The EU Commission proposed a draft proposal of amendments to the present Directives of electricity and gas and a specific regulation (2001/078/COD), where guidelines are established regarding the implementation of cross-border tariffication schemes.

xi) The 8th Florence meeting⁶⁹:

A landmark of this meeting was the green light given by the EU Commission and the CEER to the proposal of a provisional cross-border tariffication method for which ETSO had been able to reach a consensus among its members. The provisional approach was implemented on March 1st 2002.

It was agreed that a long-term approach would replace the provisional one by January 2003. The guidelines for the long-term approach were agreed and they have been listed at the beginning of the annex, as the current status of the matter on cross-border tariffication.

The CEER presented an agenda for discussing and solving cross-border trade issues in electricity and it was invited to put forward further detailed work in this respect by September 1st, 2002, with the aim of putting it into effect on January 2003.

⁶⁹ February 2002.

Annex 2. Principles of regulation of transmission network pricing

Transmission cost allocation criteria

Transmission pricing is the allocation of the regulated annual revenues of the transmission activity to the network users. The first attempt to design these prices should be to resort to nodal prices, since nodal prices are perfectly efficient short-term signals, i.e. geographically differentiated short-term marginal costs, see [Schweppe et al, 1988]. Nodal prices of energy implicitly include the effect on prices of losses & congestions in the network. They send adequate signals for decisions concerning the economic operation of generators & loads.

Strict application of nodal prices to generators and loads results in a net amount of revenues, which should be applied to partly pay for the cost of the network. Under ideal circumstances, impossible to find in practice, these revenues would suffice to pay the network total costs fully. However, these revenues are usually very insufficient to cover the total network costs (cost recovery by nodal prices typically does not exceed 20% of total transmission costs), see [Pérez-Arriaga et al, 1995].

Thus, additional signals are needed to recover the remaining transmission network costs. These costs have to be assigned to the network users so that distortion of economic efficiency is minimized. Therefore, in the first place, these signals must be *long-term signals*, so that they will not interfere with the nodal prices. This can be achieved by designing them as annual charges (although they may be distributed monthly, for instance). Ideally these long-term signals should be consistent with the underlying cost function of the transmission activity, so we must ask ourselves: which is the driver behind transmission investment? In the new competitive regulatory framework, investment in a new transmission line is justified whenever the present value of the aggregated benefits of all the network users (generators and consumers) is larger than the present value of the cost of the line. No existence of market power is assumed.

Then, conceptually, the solution is to charge the network cost that is not recovered through nodal prices in proportion to the benefits that the transmission network (either globally or line by line) provides to each one of its users. The resulting long-term economic signals have no purpose in the operation (i.e. short-term) timeframe; they are only meant to provide locational signals to new generators and loads—or to those considering retirement—, i.e. to inform them about the transmission network costs that are incurred because they locate or have located in one part of the network instead of in another one. We can see that in the long-term the elasticity of the potential new network users to the transmission charges (i.e., whether they will decide to install or not) depends on their expected profits, after transmission charges are duly included. This makes the allocation of transmission costs to the economic beneficiaries of the network to be based on the same underlying rationale than a Ramsey-like allocation scheme (i.e. allocate transmission costs to the network users in inverse proportion to their elasticities to the additional transmission charge).

Unfortunately, it happens that allocation of transmission costs to the economic beneficiaries is plagued with difficulties in practice. Most of the problems arise from the lack of adequate information about the generators in a competitive setting and the need to estimate the future behavior of the system. But also because it is difficult to evaluate the economic impact on the market agents of each individual line in a well developed network with some level of reliability-driven redundancy. This is why some measure of electrical use has been frequently adopted as a reasonable approximation to benefits (and it is also much easier to compute), see [Pérez-Arriaga, 2002]. This is the prevalent line of thought in the Florence Forum and it has been also adopted in this study.

Since nodal prices can generally only recover a small fraction of the total transmission costs, the problem of determination of transmission tariffs that pay for transmission costs will be considered from now on in this paper to be tantamount to the problem of determination of the long-term signals, regardless whether nodal pricing is applied in a system or not (although it is recommended in general).

Non transaction-based transmission charges

An important practical conclusion that is derived from the criteria of allocation of the long-term signals is that transmission tariffs should not be transaction-based. Indeed, the adopted criterion of allocation has nothing to do with the commercial transactions that the agents are engaged in at a given moment in time, under the assumption of a working market that is competitive and with perfect information. Transmission tariffs may depend on the connection point to the network, on the nature of the agent –producer or consumer—, on the amount of power injected to or retrieved from the network and on the time of injection or withdrawal, even on the economic benefits that ideally a market agent could obtain because of the development of the network, but not on whether the agent, in a particular moment in time, is buying from or selling to a power exchange or via a bilateral contract, may it be with a local or with a foreign agent.

Avoid tariff pancaking

In the context of a regional market it is very important to recognize that what intuitively seem to be fair transmission pricing rules may lead to completely wrong results. This is the case of the still prevalent rule world-wide of charging to an international power transaction that “crosses” N countries the corresponding charge of each country “as if it were a national transaction”. This seems a fair treatment from each individual country’s viewpoint, but it results in a tariffication system that depends more on the shape of political borders than on the physical reality of networks and flows. This pricing rule has two major defects: a) it is transaction dependent; b) the transmission tariff that is applied to the transaction is the accumulation of the tariffs of all the countries that have been “crossed”, therefore resulting in the so-called “pancaking” effect, instead of some kind of average regional tariff which would have been applied in a truly open regional market without political borders. The correct approach to an efficient system of regional transmission pricing is “*the single system paradigm*”, i.e. a pricing scheme that tries to get as close as it is practically possible to the transmission tariffs that would be applied if the entire region could be considered as a single country. After

more than three years of efforts, the Florence Forum reached a historical agreement on its 8th meeting of February 2002 and pancaking was finally replaced by a provisional system of inter-TSO payments (see below) still quite imperfect, while working on a consensus for a longer-term mechanism that fully incorporates the principles that are stated here.

Application of the general principles

From the general principles the following basic criteria for implementation can be derived:

-If the transmission network is well meshed and there are no clear locational signals to be sent because generation and load are more or less evenly distributed and no systematic congestions are likely to occur, then the beneficiaries (or major users) of the network cannot be clearly identified on the basis of their location. According to economic theory, in the absence of a clear indication from the underlying transmission cost function, it makes sense to recur to the inverse price elasticity rule (i.e. the concept behind Ramsey pricing) in order to minimize the loss of efficiency. This rule must provide an indication on how to split the global charge between generators and consumers and then also on how to charge to individual consumers on one side and generators on the other side. Assuming there is strong competition on the generation side, the rule advises to charge transmission costs mostly to consumers, since generation in a competitive environment is very elastic to prices and in the long-run the large elasticity of generators will result in a complete transfer of the charges to the consumers. Note that this not a trivial or universal rule, as it is sometimes heard: “consumers always pay all network charges in the end”. For instance, a new generator with a very cheap energy source (e.g. hydro or natural gas), in a remote location and with no competitors, may be charged a large fraction of the transmission line that will connect it to the major load centers without turning unprofitable the project; this network charge will not be transferred in the end to the consumers. Regarding allocation to the individual consumers, the inverse elasticity rule would advise to charge more to the least elastic consumers. Note, however, this may be considered to be an unacceptable discrimination.

-If the transmission network is such that long-term locational signals are needed and they can be more clearly identified, —because of systematic structural limitations of the network—, then the allocation of transmission costs should pay attention to location. Note that these long-term signals are no longer useful for existing generators and loads (except for those considering retirement because of economic reasons); they are meant to promote adequate siting of the new facilities and to fully recover network costs⁷⁰. However, for the sake of simplicity and avoidance of any appearance of discrimination, most

⁷⁰ Remember that signals that are derived from losses and congestions are short-term ones; they cannot generate the complete revenues for the required investment since: a) in general they will be too weak for that, due to the typical over-investment in transmission; b) these signals will typically be much reduced, -even almost disappear—, once the reinforcement is built.

regulators choose that both the existing and the new network users must be subject to the same charges. Note that it is not very important how much of these charges is recovered through generators and how much through consumers (in most cases, as indicated before, if there is strong competition in generation the consumers will end up paying the entire bill anyway). What matter are the differences in charges among generators when they are placed in different locations, so that they have the right incentive to locate in the network and, similarly, the differences in charges among consumers.

Both situations may take place at the individual system or national level. In those countries where it is deemed that there is little need for long-term locational signals in transmission, transmission costs may be allocated to generators and consumers without any geographical differentiation. This seems to be the case in most IEM countries. On the other hand, in those countries where long-term location signals appear to be necessary (e.g. England & Wales, Norway or Sweden), transmission charges could have geographical differentiation.

These criteria are equally valid in a regional or multinational context. If geographical differentiation of the long-term signals is not a major concern, then uniform regional transmission charges for generators and consumers could be applied in strict application of the single system paradigm. However this would require a very high level of regulatory integration and a pragmatic alternative could be to let each country charge its national tariffs to its network users, who in this way would automatically gain access to the entire IEM network.

However, the opposite situation may also be possible. At the regional level, one may also want to send long-term signals in order to indicate the most appropriate and inappropriate zones to locate new generation and load. If the locational problem is a serious one, —i.e. the economic utilization of generation resources at regional level to meet the regional load causes much stress in the existing transmission network—, then the long-term locational signals are needed. A rigorous approach would consist of assigning the cost of each one of the lines in the region to those agents that use it (or benefit from it) while ignoring any political borders. However, this regional tariffication scheme may be only possible in markets with a very high level of integration. Less radical alternatives are possible, such as replacing the nodal allocation of transmission costs at regional level by compensation mechanisms among countries, which would be based on how much each country uses (or benefits from) the networks of other countries, as it will be shown below.

Annex 3. Notes on the allocation key in the provisional mechanism⁷¹

ETSO has proposed a rule, —that is used in the provisional mechanism of inter-TSO payments—, of determination of the fraction of the network of a given country whose use must be attributed to other countries. This rule, or allocation key, is based on the ratio between the transits that the country has experienced in the preceding year and the total electricity consumption plus transits during that same year⁷². This rule is fundamentally flawed, as it will be shown here.

In the method proposed by ETSO (a simplified version is discussed here), hourly transits would be computed as the lower of these two values during a given hour: the total physical import flows (as measured at the border of the country) and the physical export flows (as measured at the border of the country). The yearly transits are computed from addition of all the hourly transits in the year (note that all of them are positive).

The difficulties with this method are now described:

- *The definition of transit.* This is a minor difficulty. ETSO's definition of transit is precise but it is an artifice. Other definitions might be possible, since "transit" is an ambiguous concept. An advantage of ETSO's definition is that it does not depend on the commercial transactions, —only on the physical flows at the borders-. However most people would intuitively say that, if a country has at a given time an import flow of 1,000 MW and an export flow of 1,000 MW: a) there is a transit if no agent within the country is importing or exporting electricity; b) but there is no transit if a consumer within the country has contracted the purchase of the 1,000 MW of imports and a generator within the country has contracted the sale of the 1,000 MW of exports. For the purposes of transmission network tariffication, the independence of commercial transactions of the definition of ETSO is the right thing to do, as long-term network tariffs should never depend on commercial transactions.
- *The dependence on the size of the country.* This difficulty is more important, since this dependence should not take place. Note that, the smaller a country is the larger will generally be the ratio of transits to internal consumption⁷³. Therefore ETSO's method results in smaller countries having in general a larger fraction of their horizontal networks being attributable to external users. Although smaller countries should be more prone to experience larger effects of inter-TSO payments than larger countries (see section 3 of the main text), this

⁷¹ The provisional mechanism is described in section 2.1.2.

⁷² The latest version of ETSO has introduced some sophistication over the simplified description that is used here, but the discussion is still valid.

⁷³ Note, as an analogy, that the ratio of the length of a circumference to the area of the corresponding circle increases as the inverse of the radius.

is different from the systematic and unjustified bias that results from the application of ETSO's method.

- *It may provide a completely wrong measure of the electrical use of the network.* This is by far the most important problem with ETSO's method. In a nutshell, the problem is that the result of the allocation key in ETSO's method (transits / internal consumption) totally ignores the direction of the transits relative to the direction of the internal flows within the country. If both directions coincide, then it is right to attribute to external users a fraction of the utilization of the network of the country. But if transits and internal flows have roughly opposite directions, then the "transits" are decreasing network flows and losses within the country and they should not be considered to be users of that network and charged for it. ETSO's allocation method cannot distinguish between these two cases. The type of procedure that is recommended in this document has no problem in determining the correct assignment of network utilization in each case. Note that we are not talking here about more or less precision in ETSO's method, we are talking about providing a totally wrong answer, one with the opposite sign to the correct one.

None of these three difficulties is encountered with the type of allocation procedure that has been recommended in this document. There is no need to define "transits", since the method uses the metered physical flows in the IEM network directly. The method assigns the responsibility in the use of each line to a set of nodes just by using the pattern of physical flows, regardless the political borders; then it is not dependent on the size of the country. The accuracy of the recommended procedure may be improved by adding more scenarios or by enhancing the network model, but it is guaranteed that the method will not provide fatally wrong results; the outcome of the recommended type of procedure will always be reasonable and close to what intuitively would be expected.

Case example

Let us consider the simplest possible network that still conveys the message that we are trying to send. We consider two scenarios of network flows, which are indicated in Figure 31 and Figure 32. All flows, generation outputs and loads are in MW. The political borders are not shown in the figures, but there are three countries:

- Country C1 includes node 1 and line L1.
- Country C2 includes nodes 2 and 3 and line 2.
- Country C3 includes node 4 and line L3.

The purpose of the exercise is to determine the fraction of the network of country C2 that must be allocated to external users (countries C1 and C3) in each one of the two scenarios.

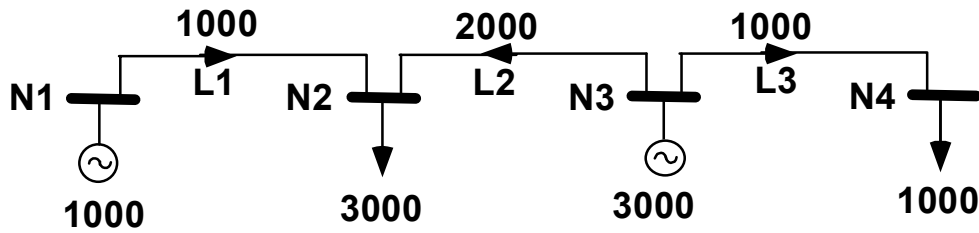

Figure 31: Scenario A of network flows

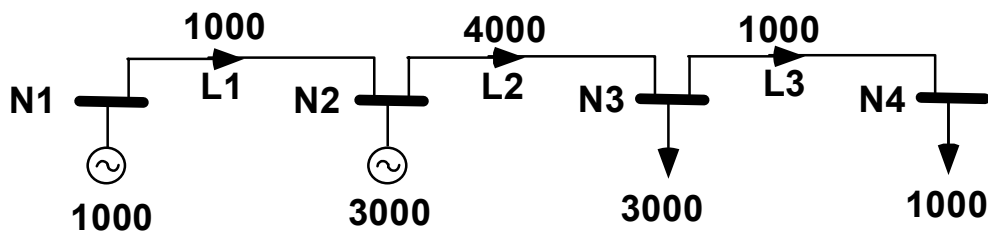

Figure 32: Scenario B of network flows

Application of ETSO's method

In both scenarios:

- The internal consumption in country C2 is 3,000 MW.
- The transit is 1,000 MW (the lowest of 1,000 MW and 1,000 MW).

Then, a fraction of $1,000 / (3,000 + 1,000) = 0.25$ of the network of C2 should be attributed to external use in both cases.

	L1 (1,000)	L2 (2,000)	L3 (1,000)
Injection			
Node 1 (1,000)	1,000	0	0
Node 3 (3,000)	0	2,000	1,000
Withdrawal			
Node 2 (3,000)	1,000	2,000	0
Node 4 (1,000)	0	0	1,000

Table 31: Participations of the agents in the flows on the lines when the average participations method is applied to scenario A

Application of the method of average participations

See in Technical Appendix 3.4.1 [Vázquez et al, 2002] a description of the method of average participations and a case example. Exactly the same procedure has been followed here.

Scenario A:

Flows in the lines that are attributed to each one of the nodes (the same rules for splitting the flows that are explained in Appendix 2 are employed here) are presented in Table 31.

The same flows in per unit with respect to the existing flows in the lines are shown in Table 32:

	L1	L2	L3
N1	1	0	0
N3	0	1	1
N2	1	1	0
N4	0	0	1

Table 32: Participations of the agents in the flows on the lines expressed in per unit values when the average participations method is applied to scenario A

The per unit values for the injection nodes and the withdrawal nodes are now put together. An equal global weight 50/50 for generators and loads is adopted. Then, all the per unit values must be multiplied by 0.5 (note that we have modified the order of the nodes in the table):

	L1	L2	L3
N1	0,5	0	0
N2	0,5	0,5	0
N3	0	0,5	0,5
N4	0	0	0,5

Table 33: Participations of the agents in the flows on the lines, expressed in per unit values, when the average participations method is applied to scenario A and an equal global weight 50/50 is used

Finally, the fraction of the network of country C2 (this is just L2) that must be attributed to countries C1 and C2 can be computed. It can be seen that the external nodes N1 and N4 are partly responsible for the use of lines L1 and L3, but in this scenario they are not responsible at all for the use of line L2. This is in agreement

with our intuition, since the “transit” of 1,000 MW from node 1 to node 4 goes counterflow to the internal use of line L2 within country C2.

Scenario B:

Flows in the lines that are attributed to each one of the nodes (the same rules for splitting the flows that are explained in Technical Appendix 3.4.2 [Vázquez et al, 2002] are employed here):

	L1 (1,000)	L2 (2,000)	L3 (1,000)
Injection			
Node 1 (1,000)	1,000	1,000	250
Node 2 (3,000)	0	3,000	750
Withdrawal			
Node 3 (3,000)	750	3,000	0
Node 4 (1,000)	250	1,000	1,000

Table 34: Participations of the agents in the flows on the lines when the average participations method is applied to scenario B

The same flows in per unit with respect to the existing flows in the lines:

	L1	L2	L3
N1	1	0.25	0.25
N2	0	0.75	0.75
N3	0.75	0.75	0
N4	0.25	0.25	1

Table 35: Participations of the agents in the flows on the lines expressed in per unit values when the average participations method is applied to scenario B

The per unit values for the injection nodes and the withdrawal nodes are now put together. An equal global weight 50/50 for generators and loads is adopted. Then, all the per unit values must be multiplied by 0.5:

	L1	L2	L3
N1	0,5	0.125	0.125
N3	0,375	0.375	0
N2	0	0.375	0.375
N4	0.125	0.125	0.50

Table 36: Participations of the nodes in the flows on the lines, expressed in per unit values, when the average participations method is applied to scenario B and an equal global weight 50/50 is used

Finally, the fraction of the network of country C2 (this is just L2) that must be attributed to countries C1 and C2 can be computed. It can be seen that the external nodes N1 and N4 are partly responsible for the use of line L2: 0.125 in per unit, or 12.5% each one of them. Therefore 25% of the use of the network of country C2 (the line L2) must be attributed to external users in this scenario. This is again in agreement with our intuition, since the “transit” of 1,000 MW from node 1 to node 4 reinforces the internal use of line L2 within country C2.

Annex 4. Some conclusions from the benchmarking study on transmission tariffs in the IEM countries

This annex refers to the study “Benchmark of electricity transmission tariffs”, prepared for the Direction General TREN of the EU Commission by the Institute of Technological Research at Comillas University in Madrid⁷⁴.

The context

The results of this study have regulatory implications within the context of the current process of implementation of cross-border tariffication in the IEM, which is based on the national network access charges G (for generators) and L (for loads) plus a scheme of compensatory economic mechanisms among TSOs that will introduce some modifications to the initial G and L values. On one hand, the utilization of the national tariffs G and L as the access charges to the entire IEM network demands some degree of harmonization of the G and L charges. On the other hand, any scheme of inter-TSO payments should rest on a common acceptance of the transmission costs that will be shared. Moreover, the meaning and the volume of the additional economic signals that result from the use of inter-TSO payments must be consistent with the existence of the independently prescribed national G and L network tariffs.

Conceptually one could think that the purpose of a cross-border tariffication scheme for the IEM should have the goal of getting as close as reasonably possible to a global mechanism of allocation of the costs of the complete IEM transmission network so that the total network costs are recovered and every generator and consumer receives an efficient long-term location signal. In addition short-term signals reflecting the impact of each network user on losses and congestions should also be included in the complete scheme. The short-term and the long-term mechanisms can be separately applied, but making sure that any revenues that might be collected by the short-term signals, —such as congestion rents—, must be used to reduce the network costs to be recovered by the long-term signals.

However, the goal of the presently accepted tariffication scheme for the IEM is less ambitious. The acceptance of the local G and L charges as the basis for the IEM access charge can be seen as a first approximation to an IEM postage stamp rate, where the specific cost differentials and regulatory practices within each national territory only affect its internal network users. The inter-TSO payments can be seen as a correction to this first approximation. This correction will be of lesser importance for all but the very small countries since, the larger a country is the smaller is the fraction of its network that is used by external transactions and the more diluted the net effect of inter-TSO payments will be on its G and L charges. It is within this global picture that the results of the benchmarking study must be examined.

⁷⁴ This note is based on the final draft of the report. The official final version has not been distributed yet by the European Commission.

Harmonization of the local G and L network access charges

The benchmarking study has shown that there are objective factors (such the size of a country, its electricity consumption and its density of consumption) that determine that the national transmission tariffs should have significantly different values in the various countries. Moreover, it has been detected that a significant part of the differences between the tariffs may be due to a combination of diverse regulatory factors (in particular, the method of valuation of the transmission asset base and the procedure of allocation of transmission charges to the different classes of network users), whose harmonization appears to be an extraordinarily difficult task. Therefore, it can be concluded that, while independently determined national tariffs are considered to be acceptable as the backbone of the IEM cross-border tariffication scheme, *no attempt should be made to harmonize the level of the transmission tariffs in the different countries.*

On the other hand, harmonization of some structural aspects of the tariffs is highly desirable and should not pose major problems. The review of the existing transmission tariffs in the benchmarking study has shown that most countries charge the transmission network costs mainly to consumers. The large variety of schemes for time differentiation does not seem to pose a significant problem, since in the end they amount to approximately equivalent results. Although the breakdown of the tariffs into fixed, energy and capacity charges shows much diversity among countries, the only part that can create significant distortions in the wholesale market is the volume of charges to generators, and specifically only the energy component of the tariff (as this part creates direct distortions in the short-term market). The market distortions can be eliminated or minimized by *setting the transmission charges of generators to zero, to a common IEM-wide figure or to some low number and/or avoiding energy charges to generators as much as possible.*

The mechanism of inter-TSO payments

Given the diversity of regulatory practices and the economic interests involved, it seems difficult that an agreement could be reached on some objective regulatory criteria, —which could be accepted by all countries—, so that they could be used to determine the authorized revenues of any transmission company in the future. However, the importance of these regulatory practices on the final value of the transmission tariffs has been clearly shown. Under these conditions, it is difficult to justify the use of the current values of the authorized costs of these networks in the computation of payments, —the inter-TSO payments—, among the European transmission system operators. A simple and pragmatic alternative is to base any inter-TSO payment scheme related to the existing network on some common standard set of per unit transmission costs to be applied to the transmission facilities, regardless the country where they are located.

It has been already indicated that the inter-TSO payment scheme, when applied to power systems as large as the majority of those comprising the IEM (e.g. France, Italy, RWE, The Netherlands, etc.), does not have the capability of sending strong long-term locational signals, —as the ones that would result from a centralized IEM-wide transmission cost allocation scheme-. This statement can be quantitatively confirmed by comparing the national transmission tariffs to the

compensations that might result from an inter-TSO payment mechanism, see Figure 33. In this figure the transmission tariffs corresponding to a representative case example are compared to the compensations in per unit of consumption that were claimed by a large group of the IEM countries (Nordel countries and Ireland and the UK did not participate in this exercise) when ETSO evaluated in April 2000 the implementation of a provisional cross-border tarification scheme that was based on inter-TSO payments that included losses and the fraction of the existing network that was considered to be used by cross-border transits. Only the per unit compensations for relatively small countries, such as Switzerland, Austria, Belgium or Portugal appear to have some significance, albeit small.

Note that the final values to be used in the modification of the G and L charges will be smaller than the ones represented in Figure 33, which only shows the per unit compensations to be received by each country. But this is a zero-sum game and it has to be also determined how much each country should pay to the others because of the compensations. It is the net outcome of the compensations and payments for each country what must be used to modify its internal G and L.

In conclusion, the quantitative results about the significance of the impact of inter-TSO payments on the independently computed national G and L transmission tariffs must be acknowledged. The modified G and L charges resulting from the application of inter-TSO payments cannot emulate full long-term IEM-wide locational network signals. Instead they are only trying to reflect the economic compensation that the IEM stakeholders and the regulators will finally agree must be due to each country, to compensate the extra costs that it incurs because of cross-border trade. And this is largely a political issue, since national networks were not designed with the IEM in mind in the first place and because cross-border trade brings difficult-to-evaluate benefits as well as costs. Stakeholders and regulators must come up with a solution that is consistent both with basic tarification principles and the pragmatic boundary conditions that this benchmarking study has revealed.

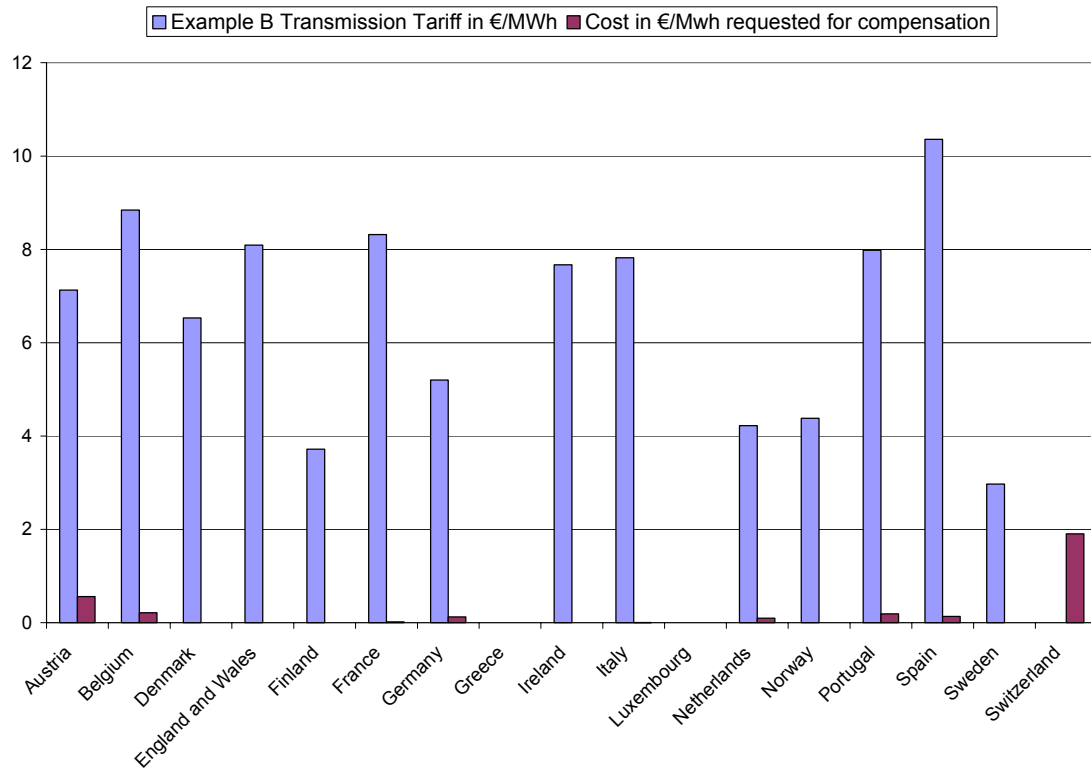

Figure 33: Comparison of actual transmission tariffs and per unit compensations (no net of charges) that are derived from inter-TSO payments

Annex 5. On the choice of slack node in the MP method

In this annex we shall examine in detail the impact that a change of slack bus has on the transmission charge for any given network user. The mathematical notation is the same that was introduced in section 3.1.4 of the main document.

For any line j , the total participation $f_{i,j}$ for a generic agent i is

$$f_{i,j} = A_{i,j} \cdot (g_i - d_i) \quad (1)$$

Being T_j the per-MW transmission charge for a generic agent i , and considering that the cost C_j of each line j is allocated to all the users in the system in proportion to their total participation in that line, the network charges for agent i are

$$T_i \cdot (g_i - d_i) = \sum_j \left(C_j \cdot \frac{A_{i,j} \cdot (g_i - d_i)}{\sum_z A_{z,j} \cdot (g_z - d_z)} \right) \quad (2)$$

where z is a dummy index representing the different agents in the system.

As it is shown in [Rivier et al, 1993], if the slack node is changed, the sensitivity factors for line j are only modified in a fixed additional term, which is constant for all the nodes. Using X_j to denominate these fixed terms, the total participation of agent i in line j with the new slack is

$$f'_{i,j} = (A_{i,j} + X_j) \cdot (g_i - d_i) \quad (3)$$

And the total network charge for agent i can be calculated as

$$T'_i \cdot (g_i - d_i) = \sum_j \left(C_j \cdot \frac{(A_{i,j} + X_j) \cdot (g_i - d_i)}{\sum_z (A_{z,j} + X_j) \cdot (g_z - d_z)} \right) \quad (4)$$

Ignoring losses, and assuming that the system is in balance, the sum of net injections $(g_z - d_z)$ for all the z agents is zero, so $\sum_z X_j \cdot (g_z - d_z) = 0$.

Then, the total payment for agent i can be re-written as

$$\sum_j \left(C_j \cdot \frac{A_{i,j} \cdot (g_i - d_i)}{\sum_z A_{z,j} \cdot (g_z - d_z)} \right) + (g_i - d_i) \cdot \sum_j \left(\frac{X_j \cdot C_j}{\sum_z A_{z,j} \cdot (g_z - d_z)} \right) \quad (5)$$

The first term in this equation is equal to the total network charge that was obtained when using the original slack bus. The second term is the same for all agents i , except for the $(g_i - d_i)$ factor, which is common to both terms. This means

that, for every network user, a change in the slack node results in an additional term K in the per-MW transmission charge. This additional term is the same for all of the network users.

$$T_i'(g_i - d_i) = (T_i + K)(g_i - d_i) \tag{6}$$

The former is true if negative participations are fully taken into account. Some implementations of the marginal participations method have chosen to consider only positive contributions, ignoring the negative ones; in that case the property described above would not hold.

The fixed term that appears modifying the unitary transmission price after a change in the slack is affected by the net injection in each bus so, whenever it is additive for any generator, it is additive for all of the generators in the system and subtractive for all of the demands, and vice versa. A slack bus located near the major load centers would tend to increase the total network charges paid by the generators and to reduce the part of the transmission price that is born by the consumers, while a slack bus close to the generation areas would increase the share of the demand in total payments and reduce the charges for the generators. A change in the slack bus is, then, just a way of determining the global percentage of the network costs to be paid by all the producers and all the consumers. In other words, if for some reason the regulator has made an a priori decision regarding the global split of the total network costs into generators and consumers, then the slack bus can be selected with no arbitrariness. Both decisions are equivalent. This is a very attractive property of the marginal participations method, and it provides some meaning to the seemingly arbitrary decision of choosing the slack node. Note, however, that other usage methods are possible (see sections 3 and 4) where the split into global demand and generation charges and the selection of slack bus can be performed independently.

Another interesting feature of the marginal participations method is that the relative location signals between nodes are not affected by a change in the slack node. The decision of a generator about whether to install at one network node or another depends, —obviously among other reasons—, on the difference between the transmission tariffs that it will be charged at the two locations. Since the difference between tariffs does not depend on the choice of slack bus, the location signal is not influenced by this decision.

Annex 6. The method of average participations: An example

The method can be easily explained from Figure 34 and Table 37 & Table 38 & Table 39. First, at each node, it is computed the net outcome of generation minus load⁷⁵. If there is more generation than load (as it is the case for instance in node 1) the node injects power into the network: it is an injection node. On the other hand, if load is larger than generation (as in node 2) the node withdraws power from the network: it is a withdrawal node. When implementing the algorithm in a computing program it is easier to deal with the injection nodes and the withdrawal nodes separately, so that the symmetry properties of the algorithm are taken advantage of. First the responsibility of the historical flow in each line and at a given time is fully allocated to the injection nodes (i.e. to the generators in these nodes). Next, the flows are completely allocated again to the withdrawal nodes (i.e. to the loads in these nodes). In this way, if desired, there is the option of assigning different global weights to injections (generators) and withdrawals (loads) when computing the final coefficients of allocation of flows. In the case example to be described next the same weight has been assigned to both. Note however, that only one run of the algorithm is strictly necessary, e.g. starting from generators, and the complete allocation to generators and loads can be obtained from the results, with 50% of the total responsibility of flows corresponding to demand and the other 50% to generators.

In the example consider the allocation to the injection nodes first. These are nodes 1 and 5 in Figure 34. Let us start with node 1. When the net injection of $100 - 40 = 60$ in node 1 reaches node 3, it is split in proportion to the net withdrawal ($80 - 40 = 40$) in node 3 and to the outgoing flow (80) leading to node 2. Then the flow of 60 entering node 3 is split into $60 \times 40 / (40 + 80) = 20$ that stays in node 3 and $60 \times 80 / (40 + 80) = 40$ that flows into line L23. The flow of 40 in line L23 is not split further, since there is no other line with outgoing flow from node 2. In this way we have determined that the injection node 1 is responsible for 60 MW of flow in line L13 (out of 60) and for 40 MW of flow in line L23 (out of 80). Node 1 is not responsible for the flows in lines L24, L34 and L45.

The case of the net injection of $200 - 20 = 180$ from node 5 is a bit more complex. The whole amount (180) flows via line 45, but when it arrives at node 4 it branches in 3 directions: a) net withdrawal of $120 - 50 = 70$ in node 4; b) the outgoing flow of 50 towards node 2 where it dies; and c) the outgoing flow of 60 towards node 3, where it continues further. This last flow of 60 is split between the net withdrawal of $80 - 40 = 40$ in node 3 and the outgoing flow of 80 towards node 2, where it dies. The split in node 3 is computed in accordance with the proportionality rule: a) $60 \times 80 / (40 + 80) = 40$ goes into line L23; b) $60 \times 40 / (40 + 80) = 20$ remains in node 3.

⁷⁵ The method can be implemented in more than one way. An alternative is to treat generation and load at each node separately, without netting them out.

The lower part of Table 37 shows how the same procedure has been applied to the withdrawal nodes.

Therefore Table 37 shows the flows in each line that are the responsibility of (that is, whose origin can be attributed to) each one of the injection nodes and withdrawal nodes (separately). Table 38 shows these same responsibilities, but expressed in per unit. It is straightforward to express these same responsibilities in per unit: we only have to divide the values in each column of Table 37 by the total flow in the line corresponding to each column⁷⁶. For instance, column 2 of Table 38 has been obtained by dividing the values in column 2 of Table 37 by 80.

Before obtaining the final Table 39, we may decide to introduce an artificial weighing factor that assigns network usage globally to generators and loads in order to obtain the final allocation factors of lines to nodes. It is again remembered that the algorithm, without any manipulation, would result in a 50/50 assignment. If it is decided that the weight should be the same, we just need to multiply all numbers in Table 38 by 0.5. However, if the desired global weight is, for instance, 30% to generators and 70% to consumers, then all the per unit values in Table 38 corresponding to injection nodes have to be multiplied by 0.3 and the per unit values corresponding to withdrawal nodes by 0.7.

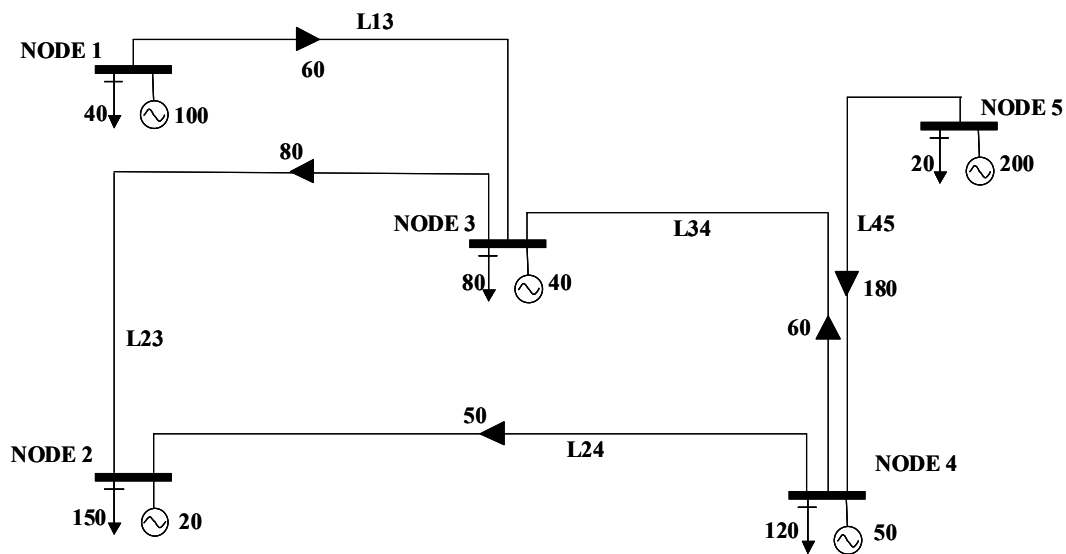

Figure 34: Five nodes example

⁷⁶ The per unit values have been obtained by dividing the flows attributed to each node in every line by the existing flow in that line. In a realistic example, when several scenarios have to be considered and the lines are not always loaded at full capacity, it is possible to weigh each scenario by the ratio: actual flow in the scenario / line capacity.

	LINE 13	LINE 23	LINE 24	LINE 34	LINE 45
<u>INJECTIONS</u>					
NODE 1 (60)	60	$60 \bullet \frac{80}{80+40}$	0	0	0
NODE 5 (180)	0	$60 \bullet \frac{80}{80+40}$	$180 \bullet \frac{50}{60+50+70}$	$180 \bullet \frac{60}{60+50+70}$	180
Total	60	80	50	60	180
<u>WITHDRAWALS</u>					
NODE 2 (130)	$80 \bullet \frac{60}{60+60}$	$130 \bullet \frac{80}{80+50}$	$130 \bullet \frac{50}{80+50}$	$80 \bullet \frac{60}{60+60}$	50 + 40
NODE 3 (40)	$40 \bullet \frac{60}{60+60}$	0	0	$40 \bullet \frac{60}{60+60}$	20
NODE 4 (70)	0	0	0	0	70
Total	60	80	50	60	180

Table 37: Allocation of flows in the lines to the injection nodes and to the withdrawal nodes of the network.

	LINE 13	LINE 23	LINE 24	LINE 34	LINE 45
NODE1	1	0.5	0	0	0
NODE5	0	0.5	1	1	1
NODE2	2/3	1	1	2/3	0.5
NODE3	1/3	0	0	1/3	1/9
NODE4	0	0	0	0	7/18

Table 38: Allocation (in per unit) of line flows to nodes, separately for injection nodes and withdrawal nodes.

	LINE 13	LINE 23	LINE 24	LINE 34	LINE 45
NODE 1	0.5	0.25	0	0	0
NODE 2	1/3	0.5	0.5	1/3	0.25
NODE 3	1/6	0	0	1/6	1/18
NODE 4	0	0	0	0	7/36
NODE 5	0	0.25	0.5	0.5	0.5
TOTAL	1	1	1	1	1

Table 39: Final allocation (in per unit) of line flows to nodes, where and identical global weight is adopted for generators and loads

Annex 7. An additional case example for the APT method

As indicated in the main text of this report, the method of Average Participations applied to Transits (APT) has been developed in the course of the present study, and therefore the only quantitative experience with the method is just the UCTE case example that has been used throughout this report to compare all the considered approaches. In order to gain some additional experience with the APT method, a new case example has been examined, where the APT method has been compared to the standard Average Participations (AP) algorithm, so that the properties of the APT method can be better understood. The new case example corresponds to a single scenario of the real operation of the NORDEL system on January 17th 2001 at 10.30 am.

The NORDEL system comprises only four countries: Denmark, Finland, Norway and Sweden, all of them participants in the Internal Electricity Market (IEM). Table 40 presents the aggregated data for the case example, while Figure 35 depicts the physical configuration of the four electrical systems and the interconnection with the neighboring ones. In the tables and figures, FIN stands for Finland, S for Sweden, NO for Norway, DK for Denmark, R for Russia, PL for Poland and D for Germany. The considered NORDEL model as a whole has 3,994 lines and transformers and 3,512 nodes, with a total amount of production equal to 60.24 GW, a total load of 58.79 GW and losses of 1.45 GW.

Table 41 and Table 42 show the numeric results that have been obtained for the compensations among countries in the NORDEL system with AP and APT, respectively. As in the main document, the results have been expressed as a percentage of the total volume of assets in the NORDEL system. The interpretation of the figures in the tables is the same one that was described in detail for Table 1 in section 3.1 of this report.

Country	Name	Demand	Generation	#D	#G	Exports	Imports	NET E-I	ETSO-T
FIN	Finland	10,403	10,218	286	197	644	969	-325	644
S	Sweden	14,415	15,024	192	179	428	1190	-762	428
NO	Norway	20,384	21,824	499	424	1081	168	913	168
DK	Denmark	6,167	6,564	117	118	984	634	350	634
R	Russia	0	992	0	5	986	0	986	0
PL	Poland	1,207	1,001	1	1	0	207	-207	0
D	Germany	2,020	1,050	3	3	34	1011	-977	34

Data in MW

Table 40: Aggregated data for the considered NORDEL scenario

A word of caution is needed regarding the results that are obtained in relation with the neighboring countries to the NORDEL system. These neighboring countries have been represented by very simplified electrical networks. This implies that the compensations that are due to the NORDEL countries from the neighboring ones will be correct, but the opposite is not true, as the actual networks of these countries are not represented in any acceptable level of detail.

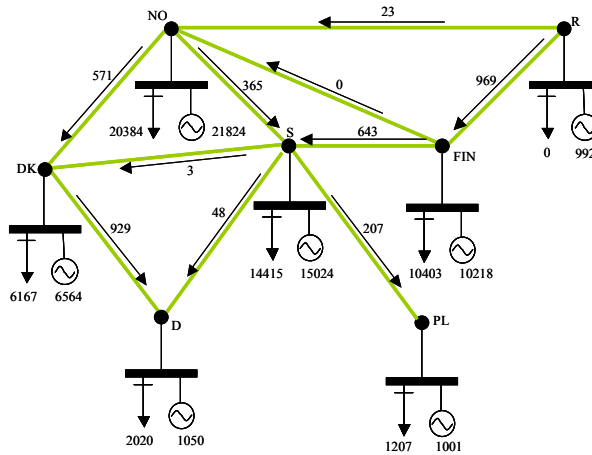

Figure 35: Aggregated data for the considered NORDEL scenario

	FIN	S	NO	DK	R_N	R_S	PL	D		
FIN	17.15	0.47	0.00	0.00	0.00	0.04	0.00	0.00	17.67	0.51
S	0.57	18.56	0.46	0.09	0.00	0.00	0.02	0.03	19.73	1.17
NO	0.02	0.32	49.12	0.38	0.02	0.00	0.00	0.01	49.87	0.75
DK	0.00	0.06	0.19	9.85	0.00	0.00	0.00	0.09	10.19	0.34
R_N	0.00	0.00	0.06	0.00	0.02	0.00	0.00	0.00	0.09	0.06
R_S	1.16	0.01	0.04	0.00	0.00	0.04	0.00	0.00	1.26	1.21
PL	0.00	0.24	0.00	0.00	0.00	0.00	0.03	0.00	0.27	0.24
D	0.00	0.11	0.14	0.55	0.00	0.00	0.00	0.14	0.93	0.79
	18.90	19.77	50.02	10.86	0.04	0.09	0.05	0.27		
	17.67	19.73	49.87	10.19	0.09	1.26	0.27	0.93		
	1.23	0.04	0.15	0.67	-0.04	-1.17	-0.21	-0.67		
	1.75	1.21	0.90	1.01	0.02	0.04	0.02	0.13		
	0.51	1.17	0.75	0.34	0.06	1.21	0.24	0.79		

Table 41: Compensations and charges with the AP method when applied to NORDEL system. Figures are expressed as a percentage of the total volume of the NORDEL grid

	FIN	S	NO	DK	R_N	R_S	PL	D		
FIN	17.55	0.17	0.00	0.00	0.00	0.00	0.00	0.00	17.72	0.17
S	0.55	19.06	0.13	0.08	0.00	0.00	0.00	0.00	19.81	0.75
NO	0.00	0.15	49.83	0.38	0.00	0.00	0.00	0.00	50.35	0.53
DK	0.00	0.04	0.03	10.04	0.00	0.00	0.00	0.01	10.12	0.09
R_N	0.00	0.00	0.06	0.00	0.04	0.00	0.00	0.00	0.11	0.06
R_S	0.77	0.00	0.00	0.00	0.00	0.09	0.00	0.00	0.86	0.77
PL	0.00	0.24	0.00	0.00	0.00	0.00	0.05	0.00	0.29	0.24
D	0.00	0.11	0.02	0.36	0.00	0.00	0.00	0.25	0.74	0.49
	18.87	19.77	50.08	10.85	0.04	0.09	0.05	0.26		
	17.72	19.81	50.35	10.12	0.11	0.86	0.29	0.74		
	1.15	-0.04	-0.28	0.73	-0.06	-0.77	-0.24	-0.48		
	1.32	0.71	0.25	0.82	0.00	0.00	0.00	0.01		
	0.17	0.75	0.53	0.09	0.06	0.77	0.24	0.49		

Table 42: Compensations and charges with the APT method when applied to the NORDEL system. The figures are expressed as a percentage of the total volume of the NORDEL grid

The conclusions that can be drawn from the results of this new case example confirm what was already presented in section 5 of the main report. The participation of external agents in the utilization of the grid of any given country or TSO is smaller with the APT method than with AP. This is because in the APT method only a fraction of the flows at the interconnections are taken into account in the computation of the external utilization of the grid of a country, namely, the fraction of the total cross-border flows that has been defined as a transit. On the contrary, when AP is applied, the complete cross border flows are considered in the computation. It is important to realize that this effect does not mean that the final *net value* of the inter-TSO payments (i.e. compensation minus charges for every country or TSO) will be larger in AP than in APT. Actually, it is the opposite here, as it was in the UCTE case example (see Table 27 in the chapter of conclusions).

As it also happened with the UCTE scenario, heavily transited countries are benefited from the use of the APT method with regard to AP, while both mostly importing and mostly exporting countries are worse off with APT. With APT those heavily transited countries receive a compensation that is similar to the one resulting from AP (since, for them, transits and total cross-border flows are almost equivalent); however, their external use of the grid of others will be smaller than the one computed under the AP approach. On the other hand, the predominately importing or exporting countries will receive with APT just a small part of the compensation that they would have been paid under AP, while there will be not much difference in the charges that they will have to pay under AP or APT.